

Hip Arthroplasty

~The Radiologist's Role in the Evaluation of Hip Prostheses~

Dr. Christina Paquette
UCSD MSK Radiology
Fellow Talk, April 2014

Disclosures:

- None.

Why *THIS* Topic?

- Based on clinical scenarios encountered during Fellowship.
 - Questions posed by ***Surgeons***, other ***Radiologists***, and even ***Patients***.
- Radiology's role is **expanding** wrt the evaluation of patients post arthroplasty:
 - Diagnostic Imaging & Intervention
 - *Routine F/U* vs. *Conservative* vs. *Revision*

Projections for Hip Arthroplasty

- Kurtz S, et al (2007):
- **2030 Projection:**
 - Need for primary total hip arthroplasties is estimated to **grow by 174% to 572,000.**
 - Hip revision procedures projected to **double.**
 - younger ages/longer life expectancy

What is the Radiologists Role?

- Choosing and optimizing imaging: *Limitations/Safety*
- Identifying complications: *Classification/Grading systems*
- Providing meaningful info to the Surgeon: *“Value-added”*
- Guiding next best step: *“Clinical pathway”/Interventions...*

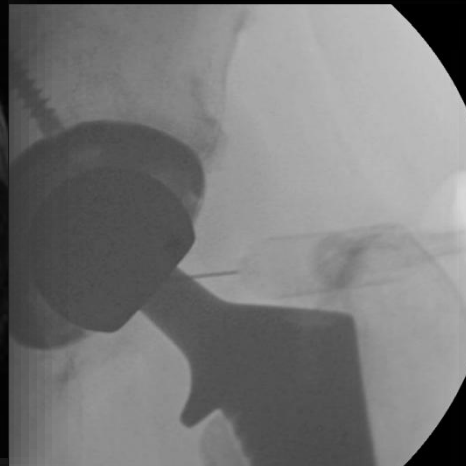
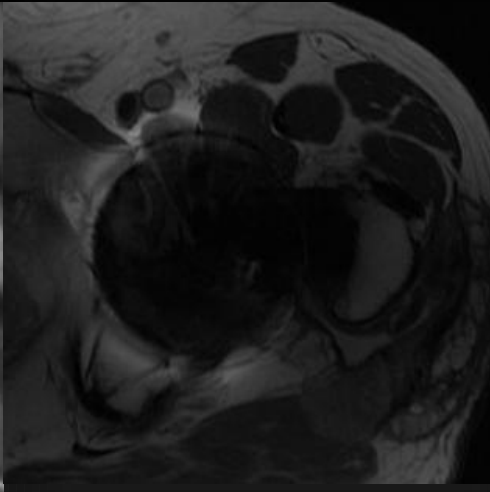

Rule out:
Sepsis
Aseptic loosening
Iliopsoas tendonitis
Lumbosacral spine disease
Extrinsic pathology

Cobalt & chromium
 serum ion level &
 imaging studies
 (MARS MRI,
 ultrasound)

Ion levels < 7 PPB
No
fluid/mass

Component position:
Satisfactory or
unsatisfactory

Radiographic
 osteolysis?

No

Re-evaluate
 for other
 cause of pain

Return
 follow-up
 in 3 to 6 months

Yes

Implant track record:
Good or poor/recalled

Consider
 revision
 THA

Ion levels < or > 7 PPB;
Fluid/mass

Component position:
Satisfactory or
unsatisfactory

Radiographs:
With or without
osteolysis

Implant track record:
Good or poor/recalled

Consider
 revision
 THA

Ion levels > 7 PPB
No fluid/mass

Component position:

Satisfactory

Implant track record?

Good

Radiographic osteolysis?

No

Re-evaluate
 for other
 cause of pain

Return
 follow-up
 in 3 to 6 months

Yes

Consider
 revision
 THA

Recalled or poor

Consider
 revision
 THA

Unsatisfactory
 ($\geq 50^\circ$ abduction;
 excessive anterversion)

Radiographs:
With or without
osteolysis

Implant track record:
Good or poor/recalled

Consider
 revision
 THA



Complications of Hip Arthroplasty:



- Early Postoperative:

- Improper placement/alignment
- Fracture/dislocation
- Cement migration
- Limb length discrepancy
- Nerve injury
- Hemarthrosis/hematoma
- Vascular injury

- Subacute/Long-term:

- Fracture/dislocation
- Loosening/component migration
- Polyethylene wear
- Particle disease
- Infection
- Adverse reaction to metal debris
- Heterotopic ossification

Comprehensive Overview:

UCSD MSK Fellow Talk, 2012
www.bonepit.com

Mulcahy H & Chew FS
*Current Concepts of Hip
Arthroplasty for Radiologists in AJR
(2012).*

Total Hip Arthroplasty:
*-component concepts and an overview
of normal and abnormal findings*

Clark Brixey, M.D.

CME
SAM

Current Concepts of Hip Arthroplasty for Radiologists

AJR
FOCUS ON:

**Current Concepts of Hip
Arthroplasty for Radiologists:
Part 1, Features and Radiographic
Assessment**

Hyojeong Mulcahy¹
Felix S. Chew

OBJECTIVE. This article will systematically review radiographic assessment of hip arthroplasty including classifications based on different types and techniques of hip arthroplasty, terminology for prosthetic designs and materials, surgical techniques, and initial and follow-up radiographic assessments.

CME
SAM

Current Concepts of Hip Arthroplasty for Radiologists

AJR
FOCUS ON:

**Current Concepts of Hip
Arthroplasty for Radiologists:
Part 2, Revisions and Complications**

Hyojeong Mulcahy¹
Felix S. Chew

OBJECTIVE. This article reviews the imaging features of revisions and complications of hip replacement arthroplasty and relates these features to the current understanding about how and why these failures occur.
CONCLUSION. Short-term failures of hip replacements are most commonly the result of instability and dislocation. Complications ranging from osteolysis caused by granulomatous reaction to particulate wear debris lead to many long-term failures. Attempts to reduce wear debris through changes in design and materials have reduced the rate of some complications but have resulted in new ones. Infection remains a devastating complication that is difficult to resolve.

Complications of Hip Arthroplasty:

• Early Postoperative:

- Improper placement/alignment
- Fracture/dislocation
- Cement migration
- Limb length discrepancy
- **Nerve injury**
- Hemarthrosis/**hematoma**
- Vascular injury

• Subacute/Long-term:

- Fracture/dislocation
- Loosening/component migration
- Polyethylene wear
- **Particle disease**
- Infection
- **Adverse reaction to metal debris**
- **Heterotopic ossification**



[1]

Heterotopic Ossification

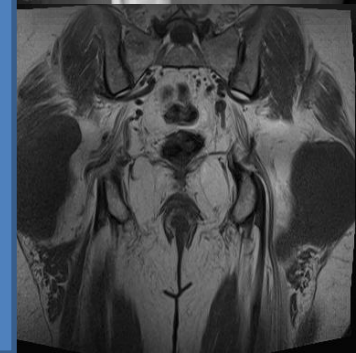
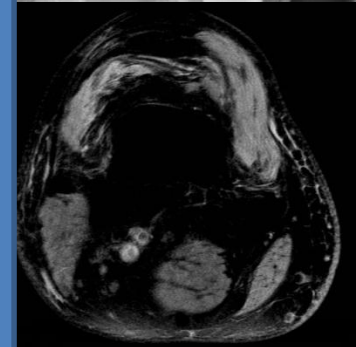

54 year old male, osteoarthritis and left hip pain.

54



Post-OR: Persistent hip pain limiting ROM, mild erythema/warmth, minimally elevated ESR...

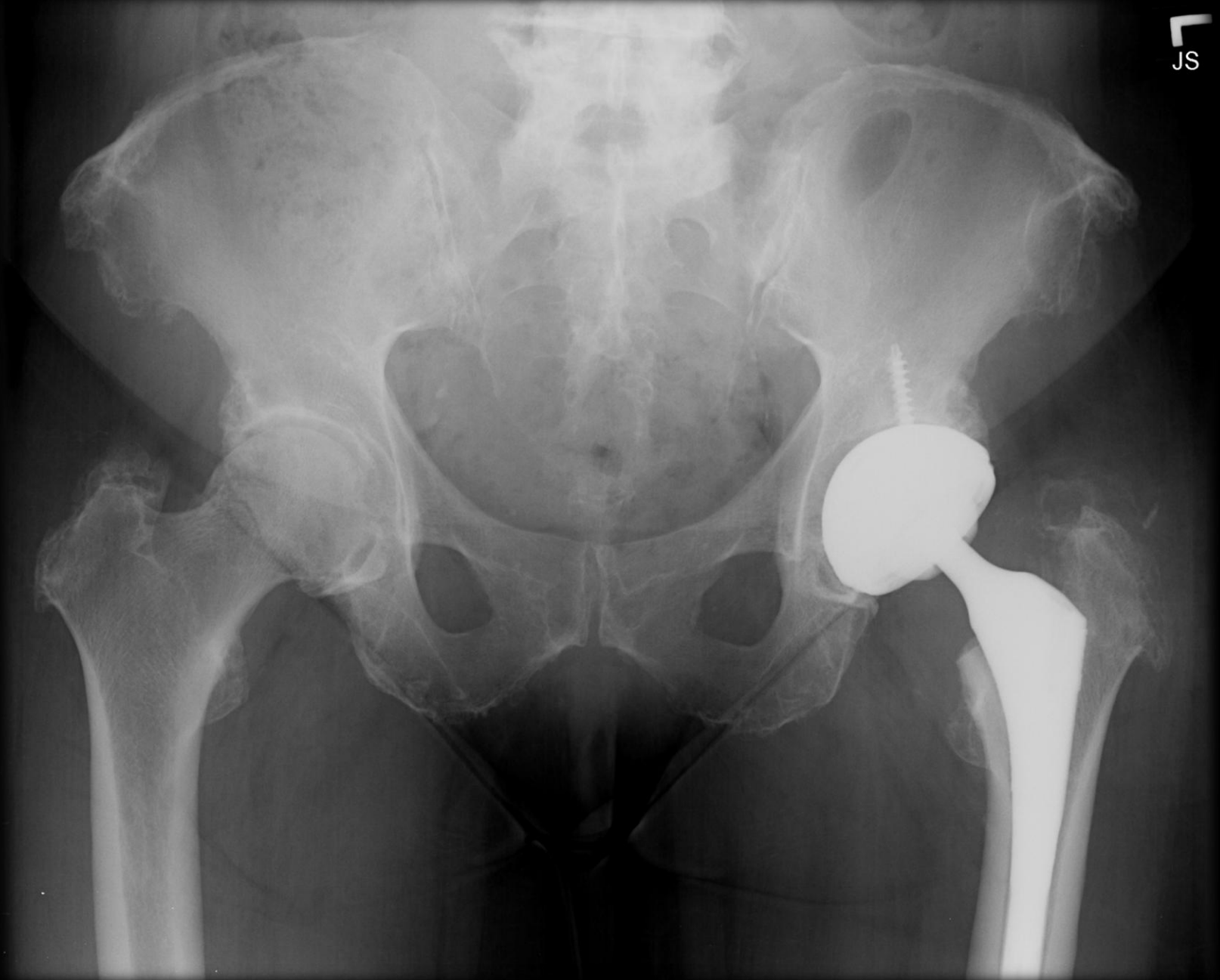

Serial Radiographs...

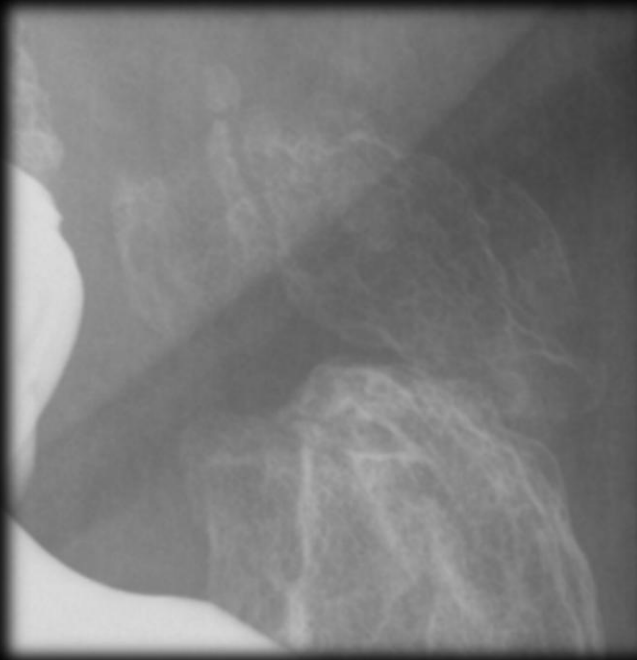
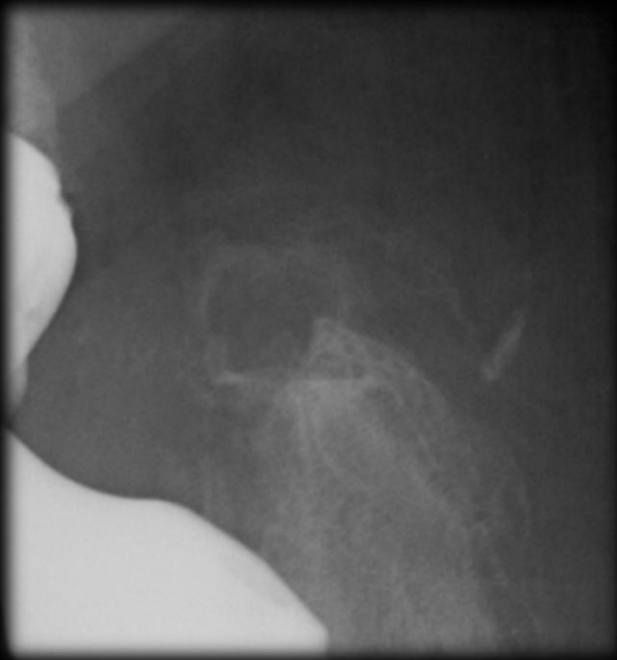

Heterotopic Ossification:

- 60-90% pts, 1-2% clinically significant:
 - Painful* (*elevated ESR, warmth/erythema*)
 - Decreased ROM: impingement/instability
- Etiology? Induction of osteogenic precursors in para-articular ST's:
 - BMP's/PG-E2, OB's>OC's, ectopic bone in ST's
- Prevention:
 - identify those at risk, surgical technique, prophylactic measures.

Risk Factors for HO formation post THA:

Hx HO in post contralateral THA

M:F 2:1

Bilateral severe OA

Advanced age

DISH/AS (*confounders: male/osteoarthritis*)

Sx Approach: *anterolateral with anterior trochanteric osteotomy*

Uncemented femoral stem

Prevention of HO in High Risk Patients:

- **1) NSAIDs:**
 - indomethacin/COX-2I:
 - ~ 7days post-THA
- **2) Bisphosphonates:**
 - inhibit crystallization of calcium phosphate
 - pre-op → 3-4 months
 - *osteomalacia*
- **3) Low-dose Radiation:**
 - 6hrs (pre) → 16hrs(post)
 - Can be used to halt progression as well...
 - 800/700/600 cGy in single fraction.
 - **shielding blocks*

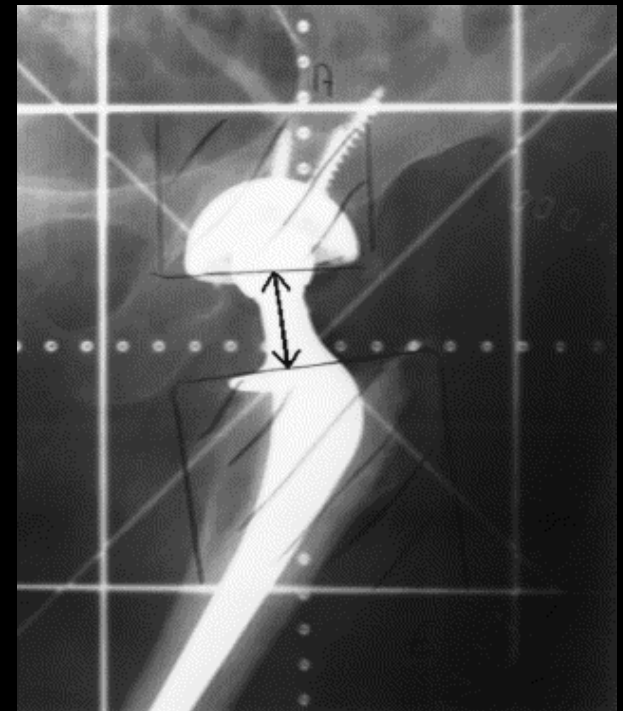

[<http://www.aboutcancer.com>]

HO: Diagnosis and Imaging Findings

- ↑ alkaline phosphatase/ESR >35mm/hr 12 weeks post-Sx.
- “Brooker Classification of HO after THA” (1971):
 - *based on *supine AP radiographs*.
 - c/w hip ROM (not Harris Hip Score).
 - Decreased ROM = primary reason for surgical resection of mature HO.

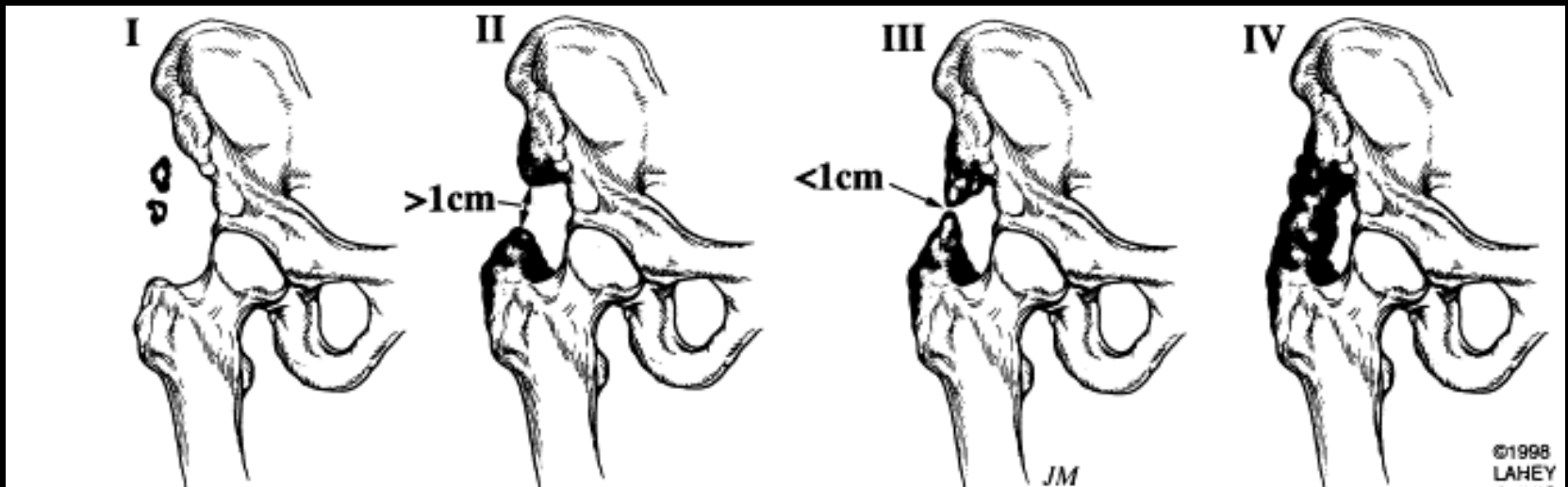

NB: “Mayo Clinic Grading System” also commonly used, similar premise...

Not an imaging conundrum...



[Kantor SR, Sem in Arthro. 2005; 16:105-113.]

HO Stage “O”:

- New addition to Criteria?
 - No radiographic abnormality
 - CT Imaging:
 - *low density regions of “fluid or soft tissue attenuation” without evidence of calcification.*

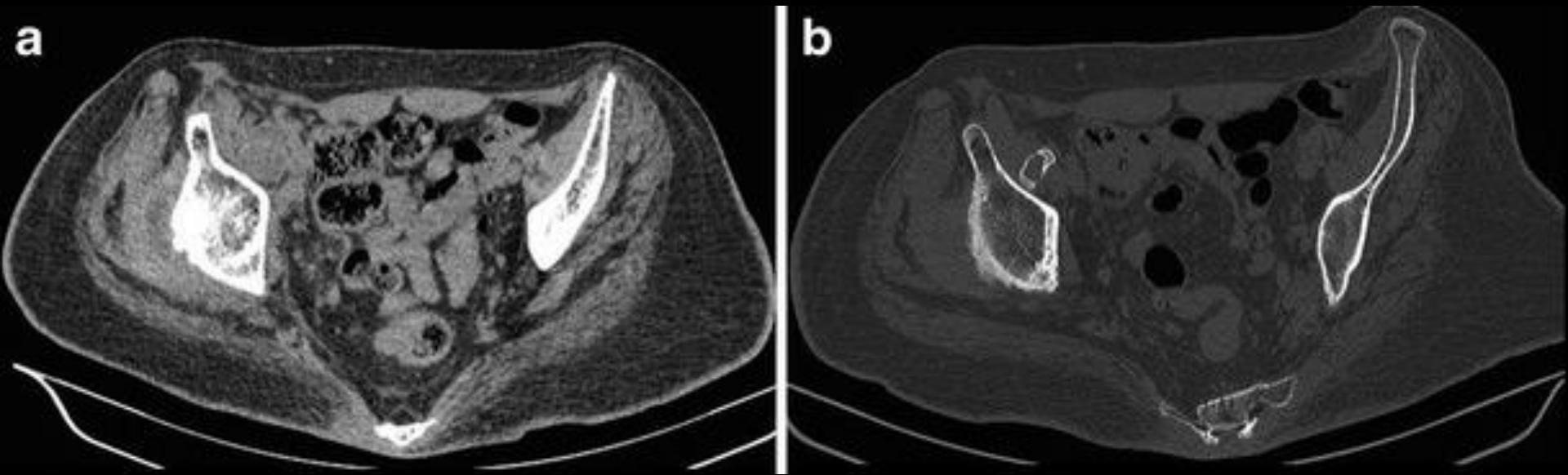

50 year old male with spinal cord injury, febrile, and elevated ESR.



50 year old male with spinal cord injury, febrile, and elevated ESR.

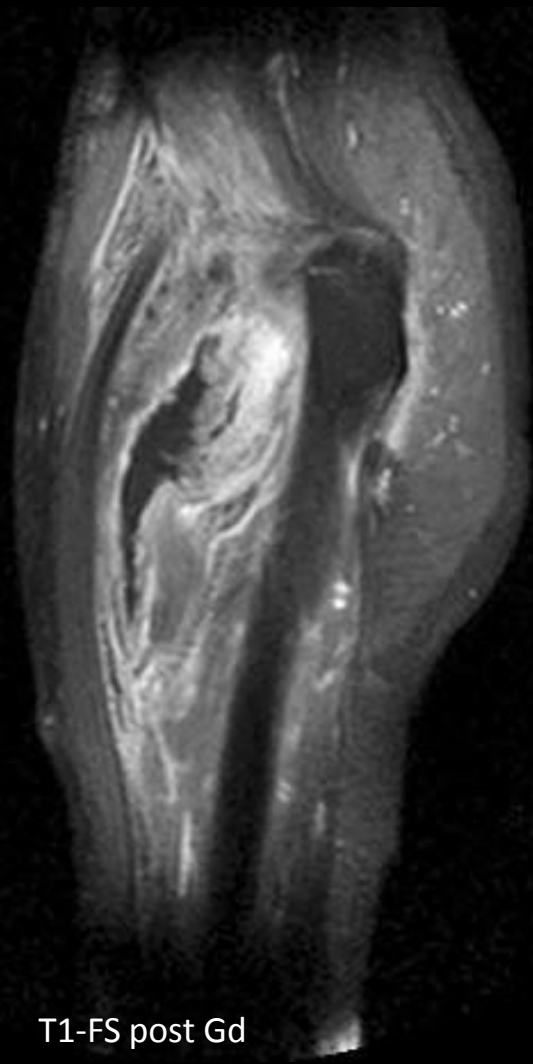
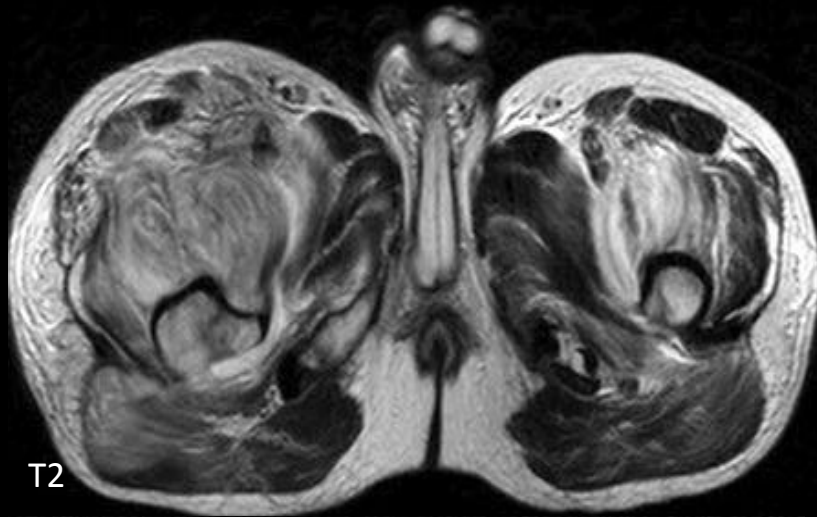

50 year old male with spinal cord injury, febrile, and elevated ESR.



**Early Presentation of Heterotopic Ossification
Mimicking Pyomyositis**

MRI of Pelvic Heterotopic Ossification

- 141 distinct sites of HO (in 36 pts) by CT/CR who had MRI w/i 3 months.
 - paralyzed/bedridden pts with MRI for “r/o osteomyelitis”
- ?MRI characteristics of HO in various stages of maturation.

No	Maturity of HO	Criteria
20	Grade 1	Fluid attn, no evidence of Ca+ (CT only)
39	Grade 2	Ca+ in the soft tissue, no bone (CR/CT)
30	Grade 3	Immature bone formation (CT/CR)
52	Grade 4	“mature bone” (CT/CR)*
141 total		<i>*not intended for assessing maturity for Sx resection...</i>

MRI of Pelvic Heterotopic Ossification

- MR imaging evolution of increasing maturity of HO:

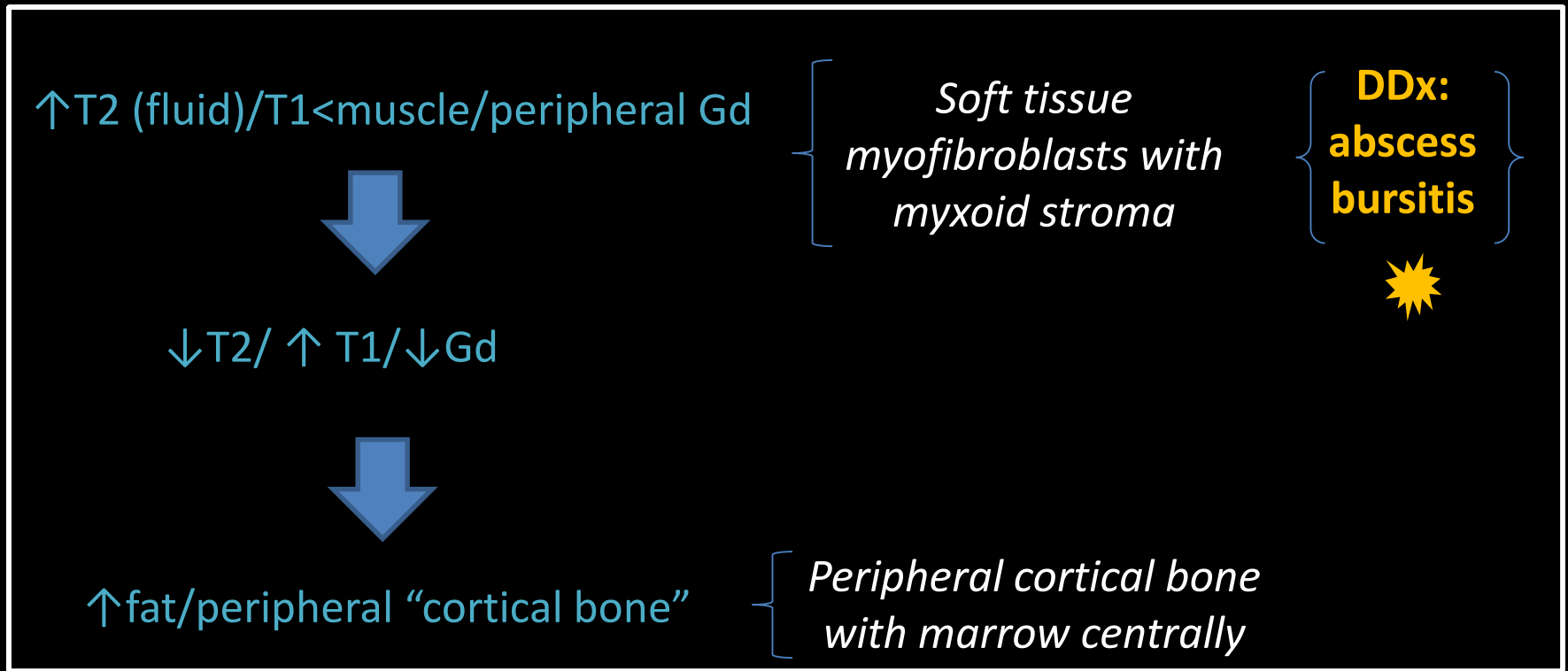

Treatment of Established HO

- Indications for Surgical Intervention:

- Brooker Class III/IV
- ↓ROM
- ?Pain
 - If related to impingement.

- Surgical Resection:

- Once HO reaches maturity (1-2 years; up to 5 years)
 - 1) Stability on CR*?
 - 2) Serum alkaline phosphatase @ normal levels?
 - 3) Tc-99M uptake similar to surrounding bone?



***“Heterogeneity of HO maturation”:**

= Bone Scan evaluation more reliable than stability on CR

Key Points: Heterotopic Ossification post-THA



- HO classification (Brooker)
- Early MRI findings:
 - *immature HO may be difficult to differentiate from other pathologies, such as soft tissue abscess and septic bursitis.*
- CT more specific for HO in early stage
 - *amorphous peripheral Ca+*
- Surgical resection once mature, best determined on NM
 - *not CR; “heterogeneity of maturation”.*
- MRI: maturation?/extent
 - *relationship with neurovascular structures for pre-operative planning.*

Pre-operative MRI for HO resection:

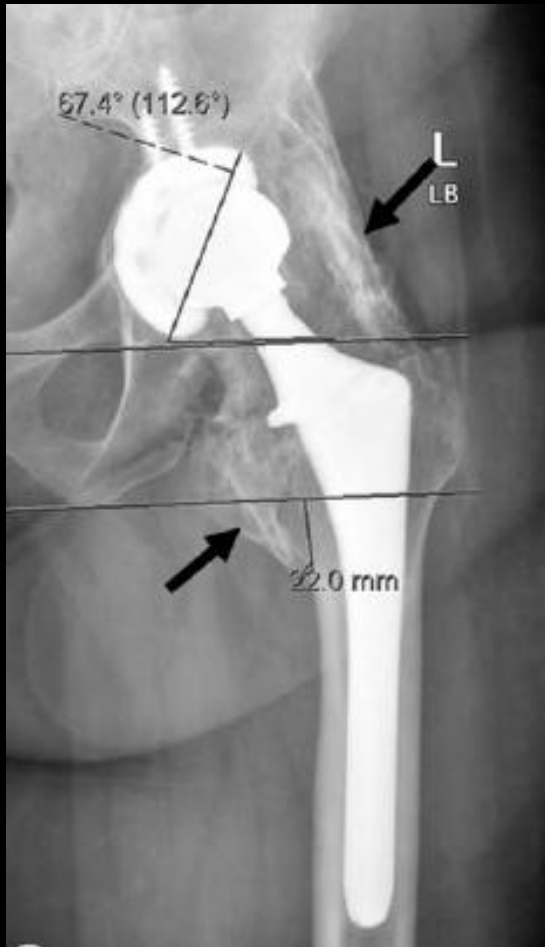

(Brooker grade IV)

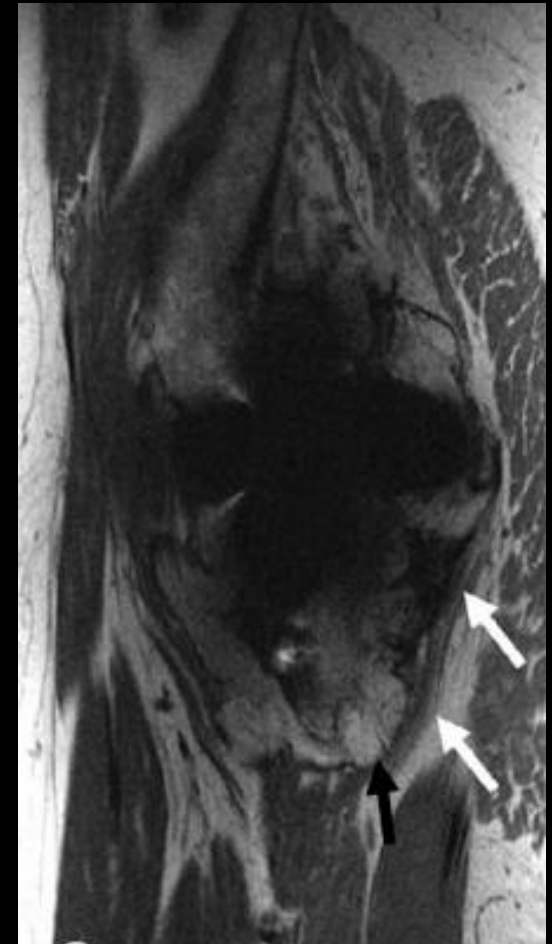
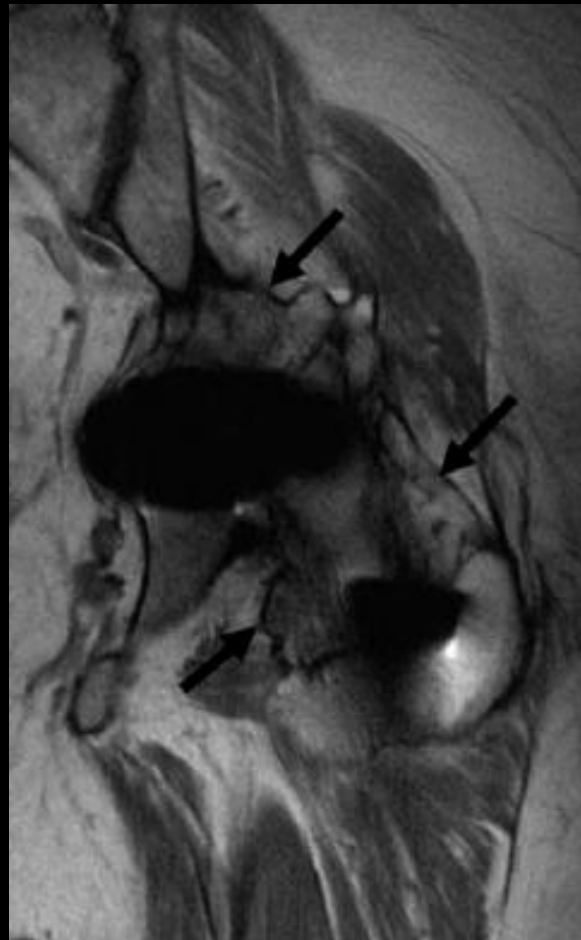

[Heterotopic ossification displacing the sciatic nerve]

[2]

Neuropathy

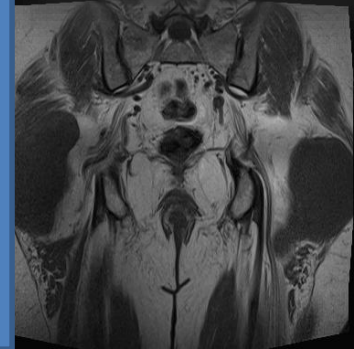
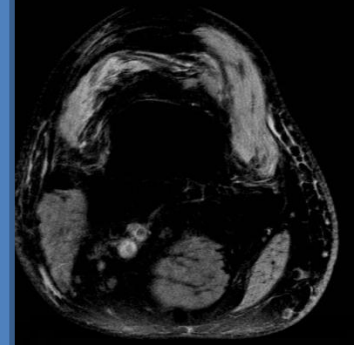

49 year old male, s/p right THA , with progressive weakness of knee extension and sensory deficit of the anteromedial thigh and leg.



Previous MRI
(*Outside Institution*).

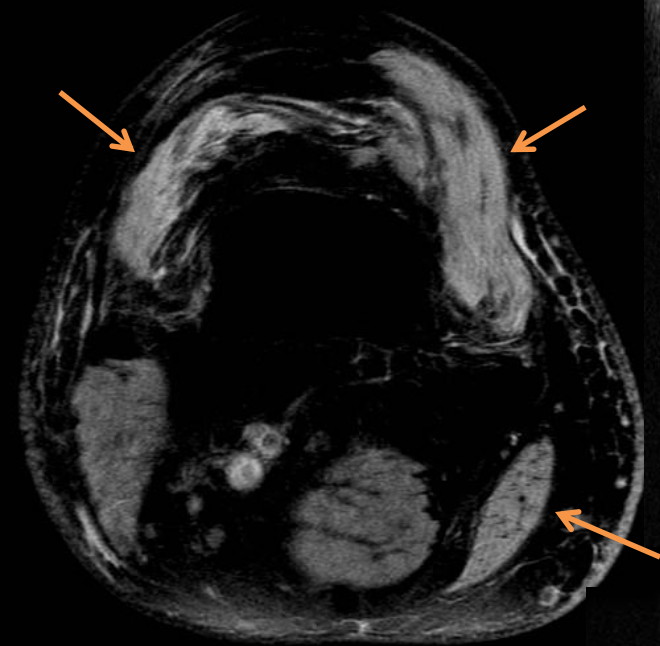

Abnormal muscle
edema in the
quadriceps musculature
and sartorius
compatible with
**femoral nerve
dysfunction.**

Neuropathies associated with Hip Arthroplasty

- **Prevalence** – 1%
 - *ischemia, transection, cautery, compression, tension.*
- **Risk Factors:**
 - Females (*twice that of males*)
 - Revision surgery (*2.6%, vs. primary surgery 0.9%*)
 - DDH **highest (5.2%)*
 - Acute limb lengthening (*>2-4cm*)
 - Bleeding (*hematoma*)
 - Coexistent spinal stenosis
- **Distribution:**
 - ***Sciatic Nerve*** (**Common Peroneal Division*)
 - ***Femoral Nerve***
 - Obturator Nerve
 - Superior Gluteal

Neuropathies: The Role of Imaging.

- 1) Identify denervation pattern of muscle edema.
- 2) Attribute to specific nerve distribution.
- 3) Look for potential cause:
 - nerve transection/neuroma
 - displaced acetabular screws
 - extravasated cement
 - heterotopic ossification
 - scar tissue
 - synovial expansion
 - expansile osteolytic lesions
 - **hematoma*

If recognised and treated early, the nerve injury may be reversed

Femoral Nerve

- L2-L4
- Main function to **extend knee**:
 - post-op setting: *“push knee posterior toward bed”*
 - Motor: **pectineus, sartorius, quadriceps musculature**
- Courses through psoas muscle → b/w iliacus and psoas muscles → beneath inguinal ligament → emerges as lateral most structure in femoral triangle.
 - At risk with improper placement of **anterior acetabular retractors**.
 - **Retroperitoneal hematoma** (*anticoagulation)

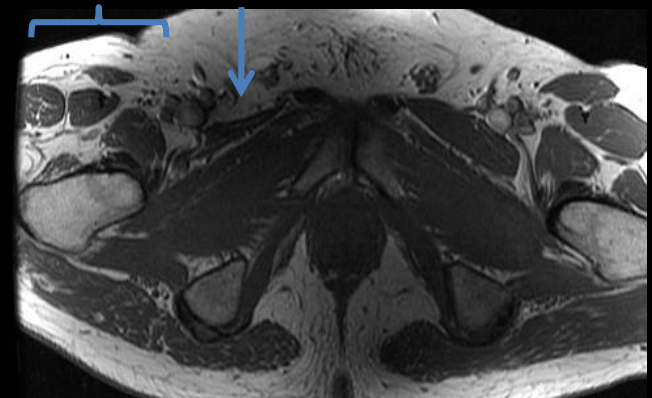
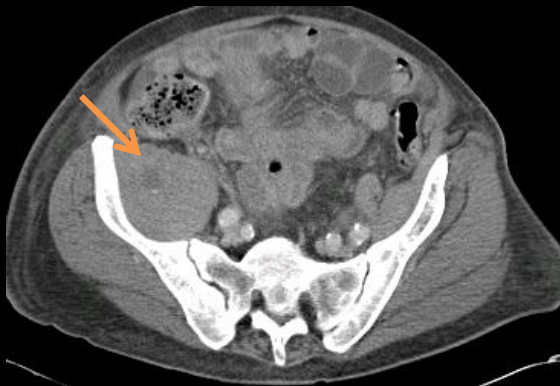
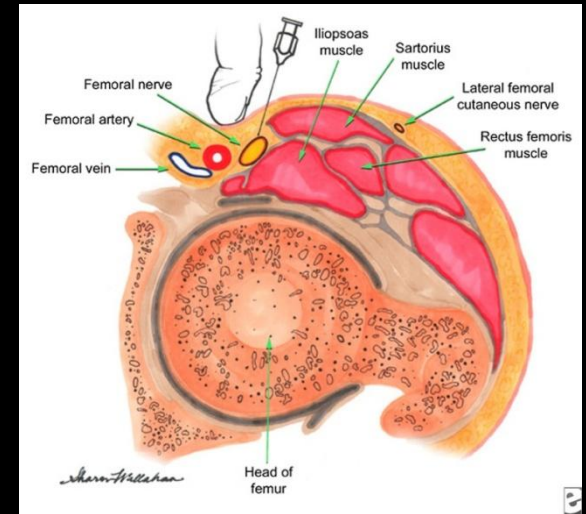

[Iliacus hematoma resulting in compression of the femoral nerve:]

Femoral nerve:

Synovial expansion w/ decompression into iliopsoas bursa.

Wear-induced synovitis decompressing into the iliopsoas bursa causing compression of the femoral nerve.

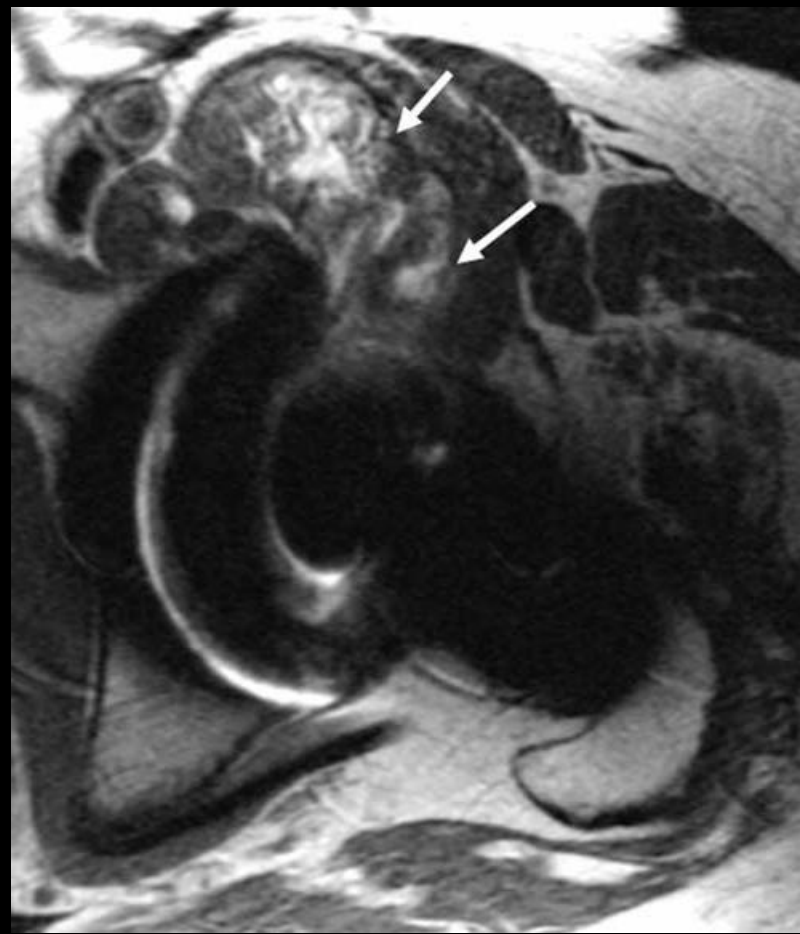
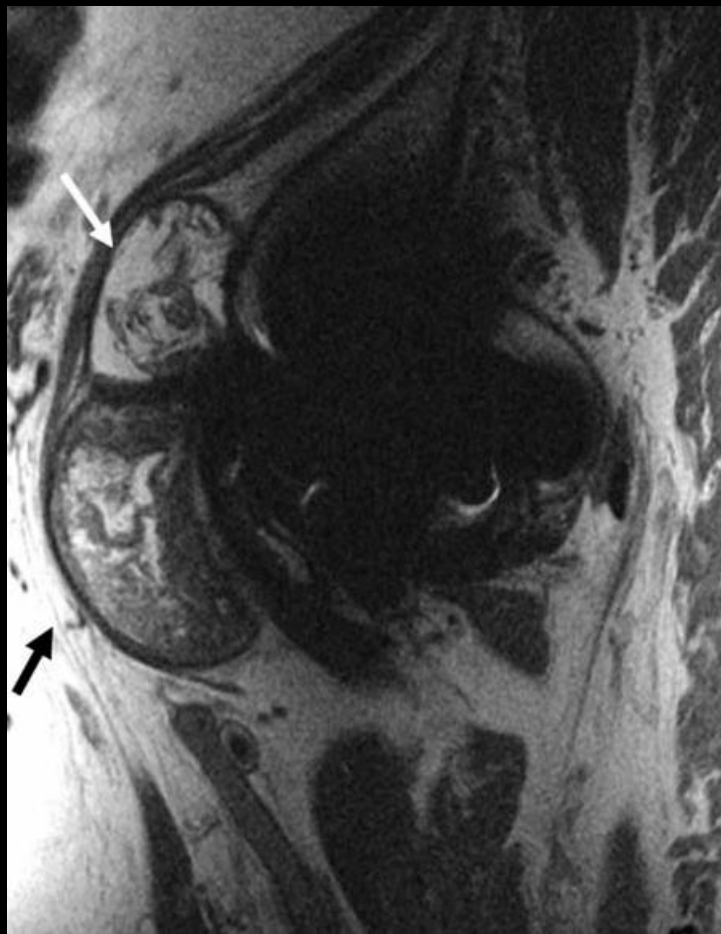

Sciatic Nerve

- L4-S3
- M: Hamstring muscle complex, +/- add. magnus and all muscles of the L/E.
- 2 divisions/one sheath:
 - **tibial** and **common peroneal nerves**
- **CPN: ↑ susceptibility to damage, accounts for ~80% of all neuropathies a/w THA.**
 - *More lateral and variable course*
 - *Relatively tethered at sciatic notch and fibular neck.*
 - *Fewer & larger funiculi*
- P/E: Great toe/ankle dorsiflexion.
- EMG: Short head of biceps (*distinguishes proximal from distal*).

NB: 41% recover/44% mild persistent *deficit*/ **15% poor outcome**
(dysesthesias/weakness).

Sciatic Nerve:

Pre-operative MRI for HO resection:

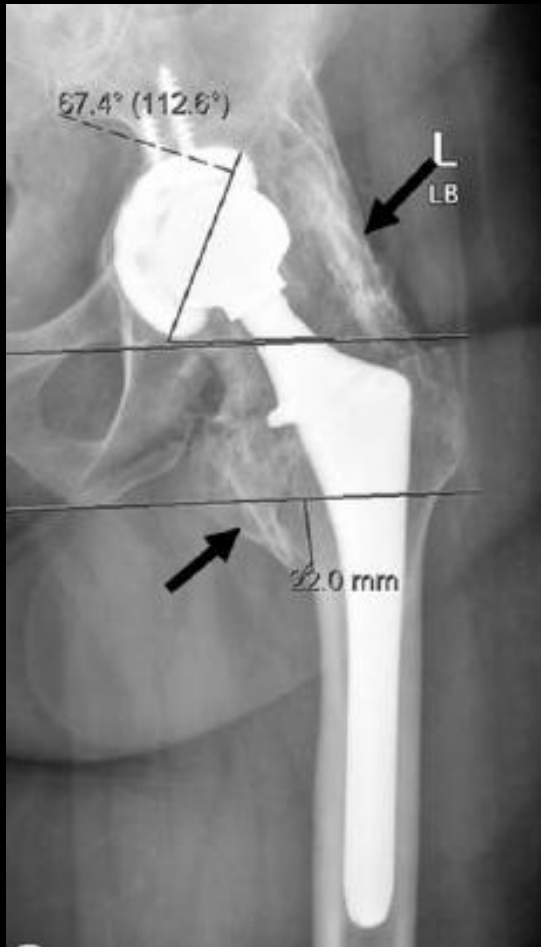

(Brooker grade IV)

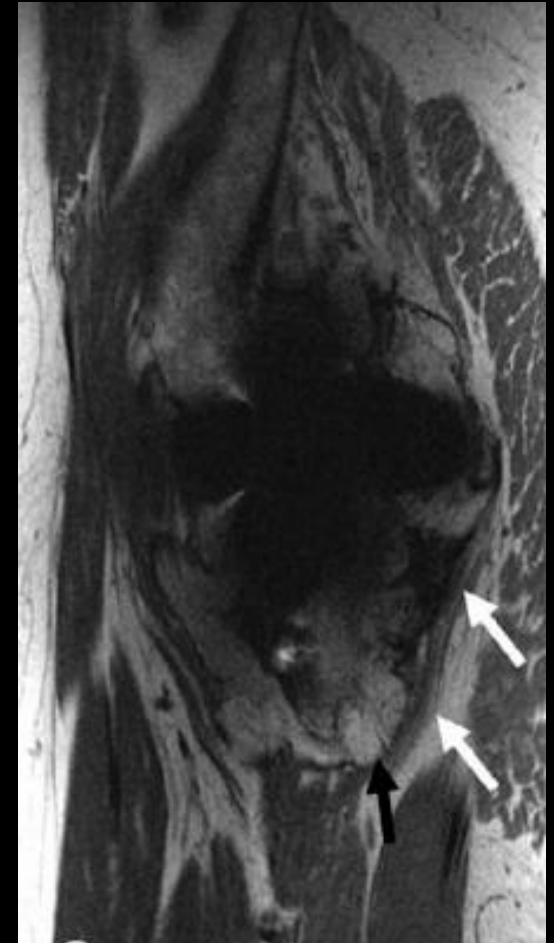
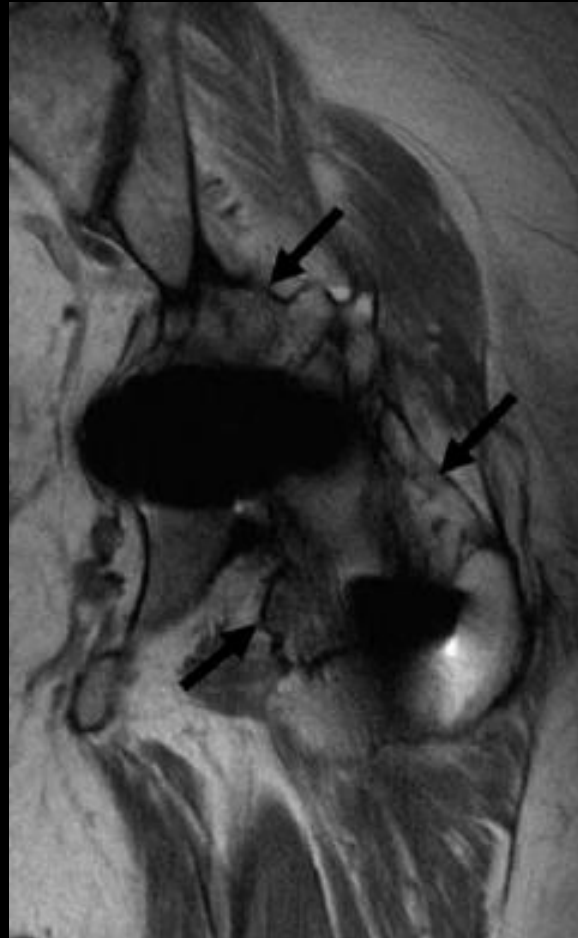

[Heterotopic ossification displacing the sciatic nerve]

Clinical Scenario to be aware of:

Expanding Hematoma Presenting with Neuropathy.

May warrant exploration of wound, hematoma evacuation, and identification/control of bleeding source.

1] Hematoma expanding into gluteal compartment:

- ↑ risk of *sciatic nerve* injury
- ↑ risk of gluteal artery compression/*muscle ischemia.

[74 year old, status post fall 1 month ago]

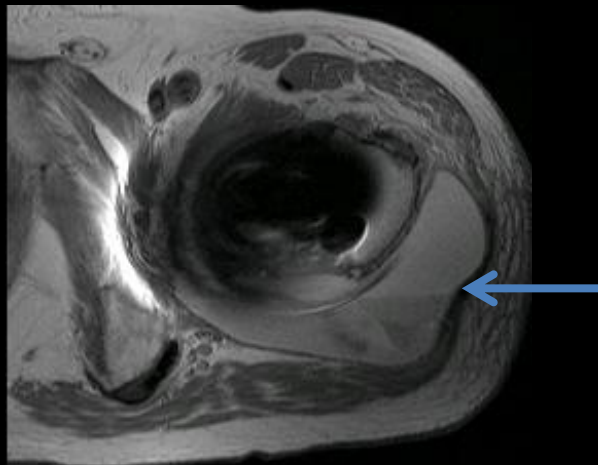

2] Hematoma resulting in femoral nerve palsy :

- **medial wall perforation** with iliacus hematoma.

[67 yo female with femoral nerve palsy 3 days post THA]

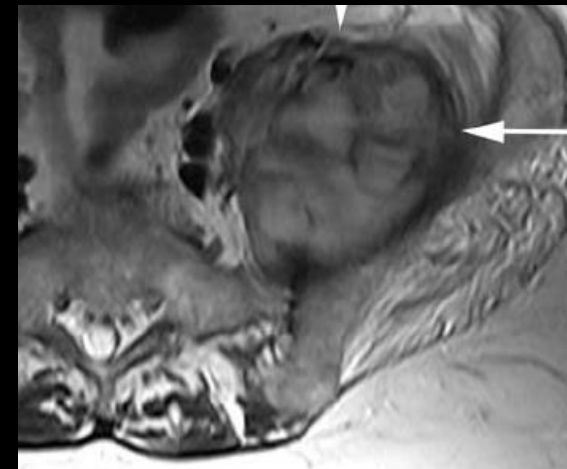
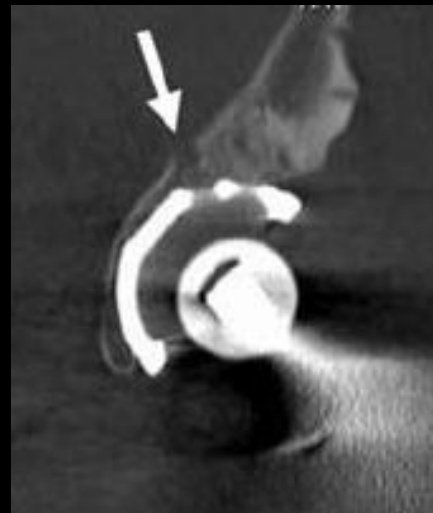

Key Points: Neuropathy post-THA

- Recognize patterns of potential denervation changes.
- Look for potential cause
 - Proximal to FOV?.
 - *Hematoma and femoral neuropathy.*
- MRI findings of denervation edema
 - *Unclear if absence of fatty atrophy is indicative of potential reversibility.*
- Even in presence of fatty atrophy:
 - *Important information to provide wrt PT and Rehab.*
 - *Pt expectations.*

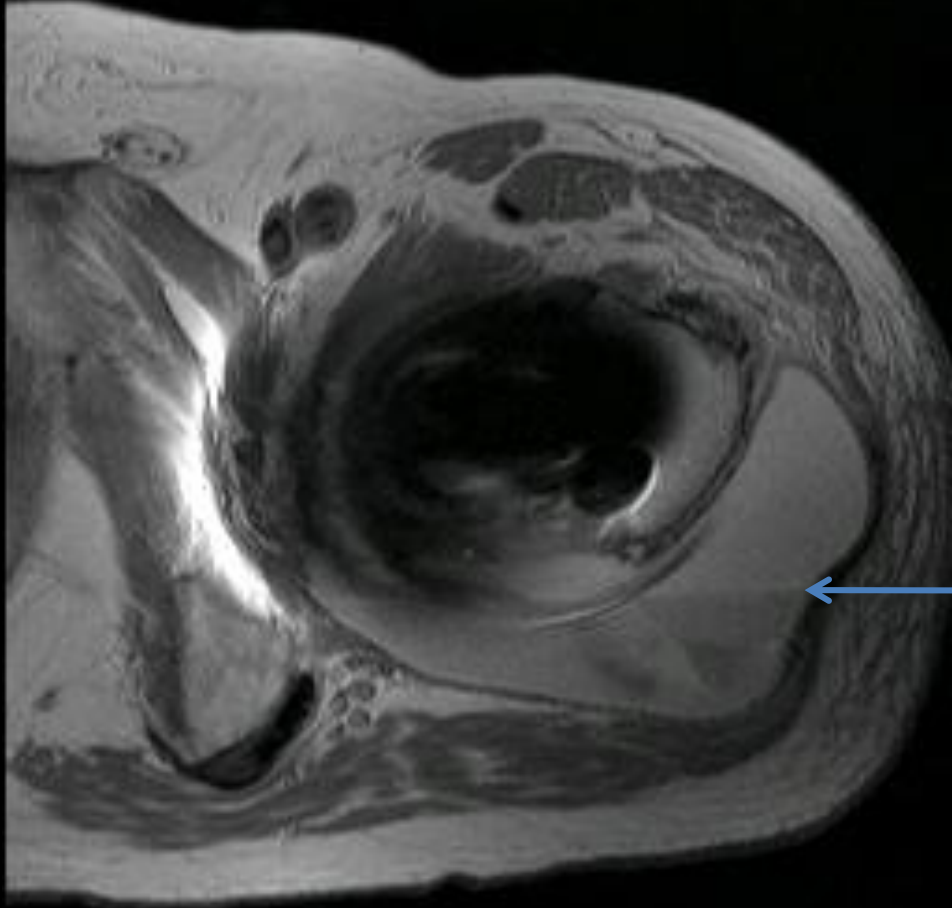

[3]

Adverse Reaction to Metal Debris

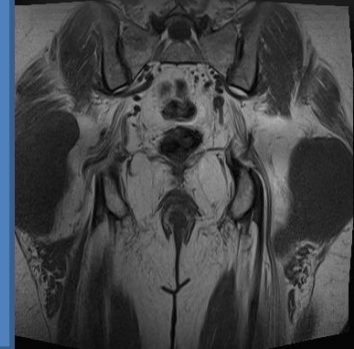
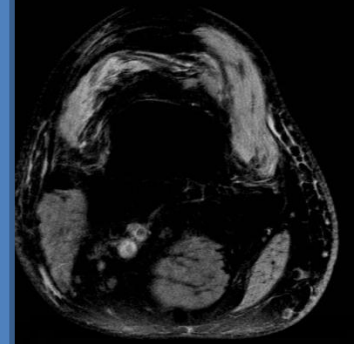

1] 73 year old male with metal-on-metal replacement with elevated cobalt and chromium levels and fluid collections noted on ultrasound.

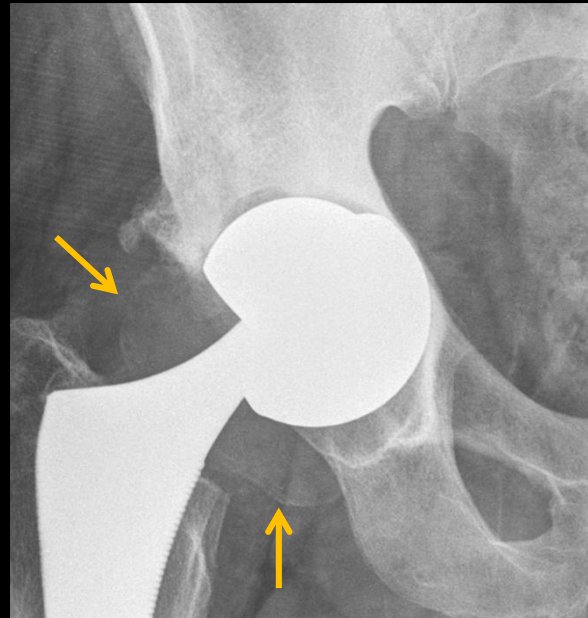
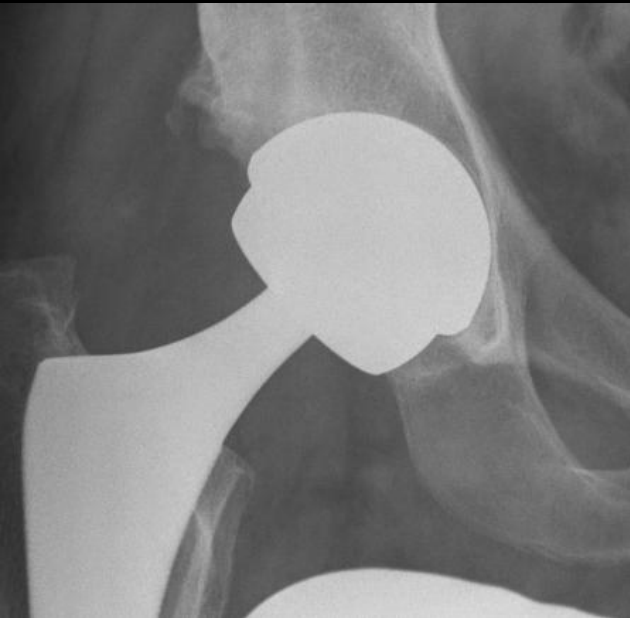

[Deposited metallic debris
along joint space]

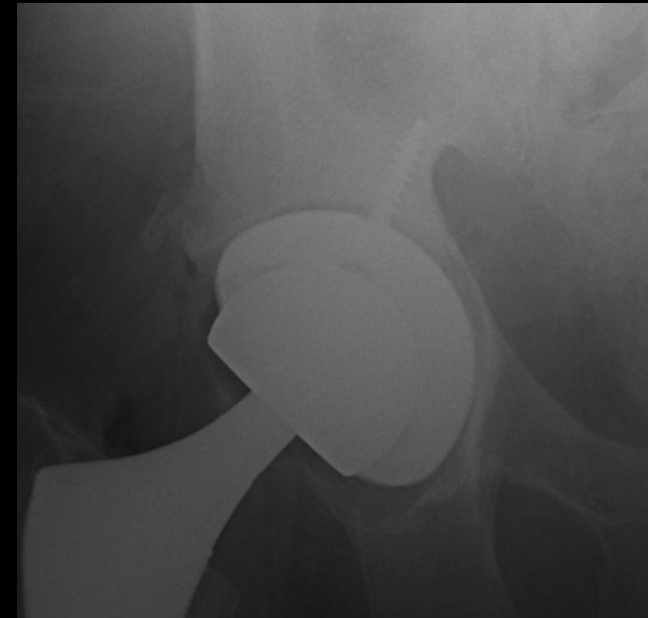

[Revision arthroplasty
with M-on-PE]

2] Asymptomatic patient with bilateral metal-on-metal replacement with elevated cobalt and chromium levels.

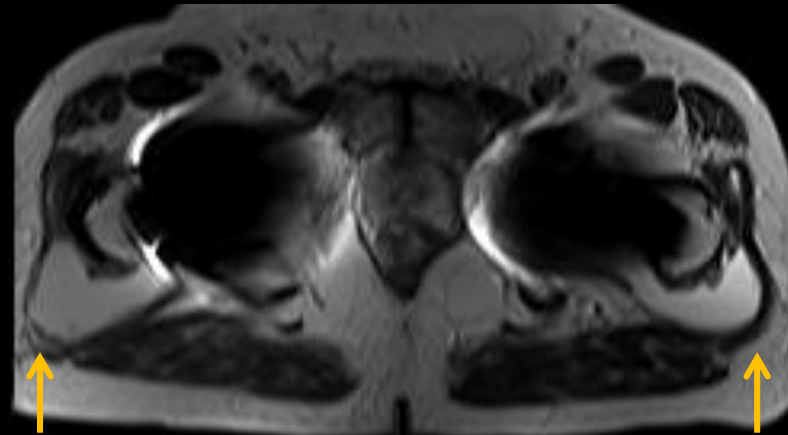
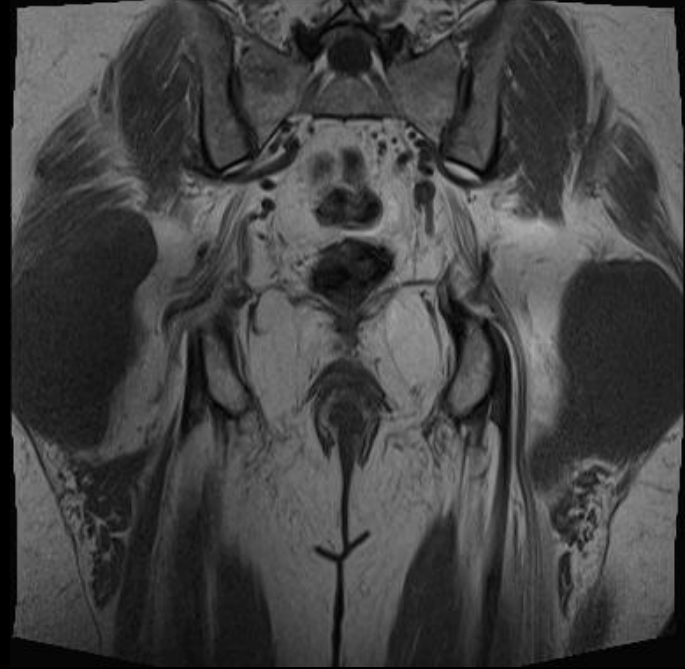
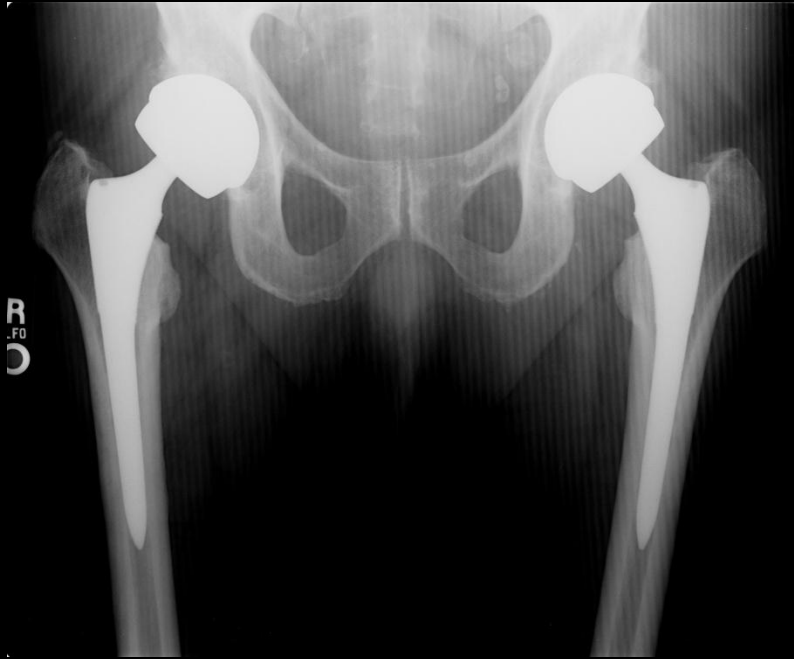

MoM and ARMD

Pure Metallosis → Aseptic lymphocytic vasculitis associated lesion (ALVAL)

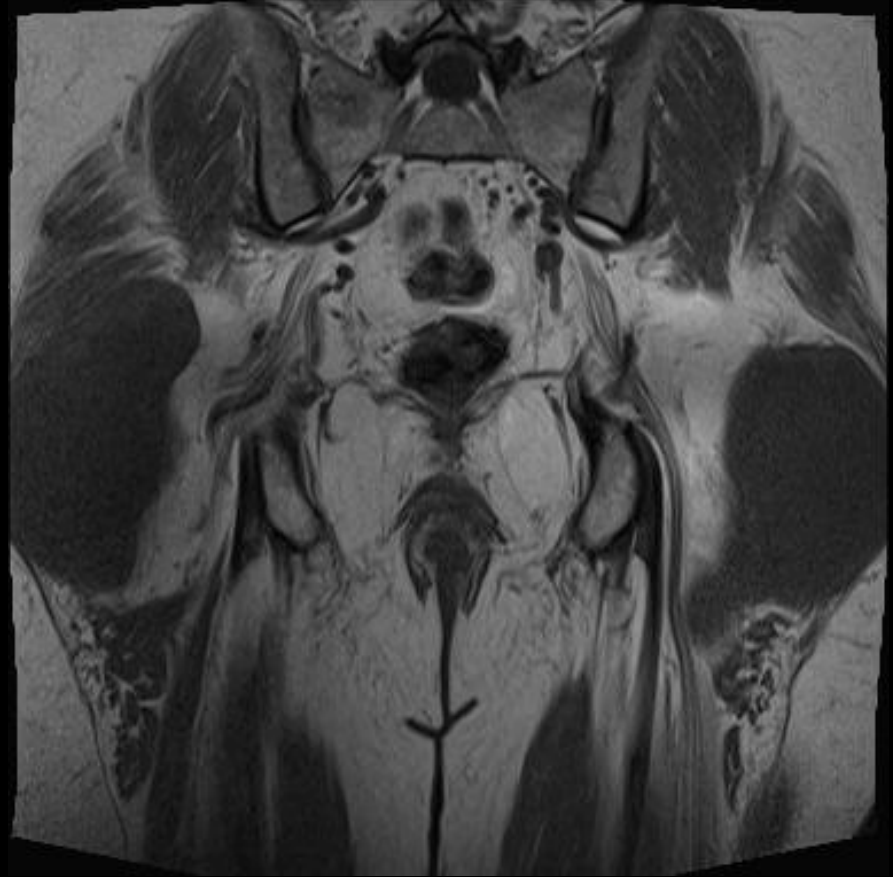

MoM Athroplasty: Background

- MoM arthroplasty Introduced 1960's.
 - “cement disease” & loss of bone stock with revisions.

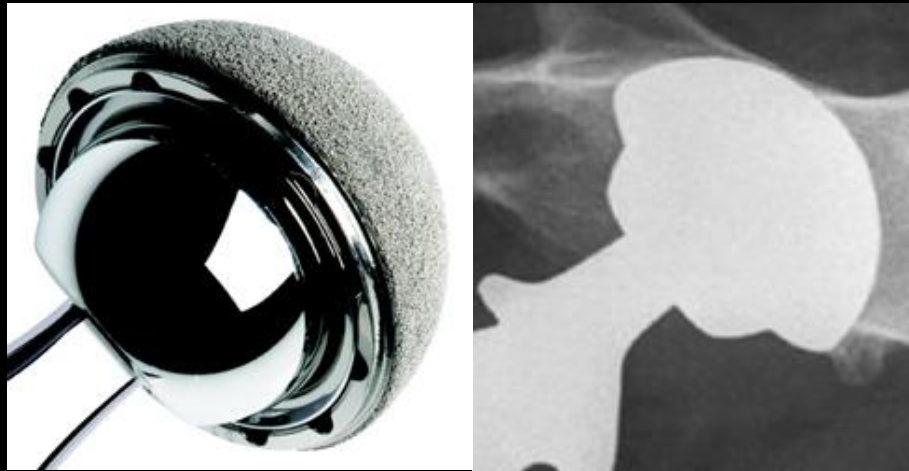

Benefits:

Durable/long lasting
Low level of wear particles
Younger/active patients

MoM Athroplasty: Background

- In **2005**, a distinctive inflammatory rx seen in failed MoM hip arthroplasties recognized:
 - perivascular chronic lymphoproliferative infiltrate in the subsynovium with high endothelial vessels (**HEVs**).
 - **Similar pathology RA/PA**, histological differentiation based on **extensive surface necrosis** and **metallic debris w/i macrophages**.
- Adverse reactions to metal debris (**ARMD**) consist of a spectrum of changes ranging:
 - **pure metallosis** to **aseptic lymphocytic vasculitis associated lesion (ALVAL)**.

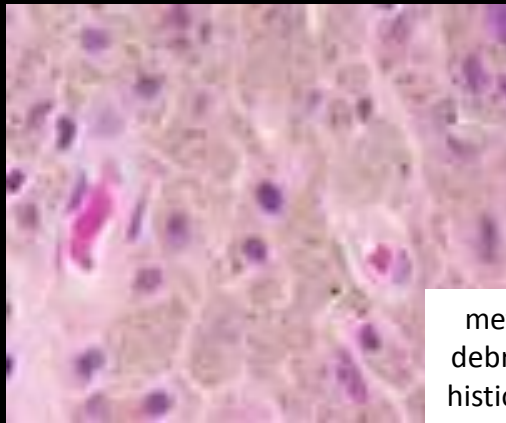

metallic
debris w/i
histiocytes

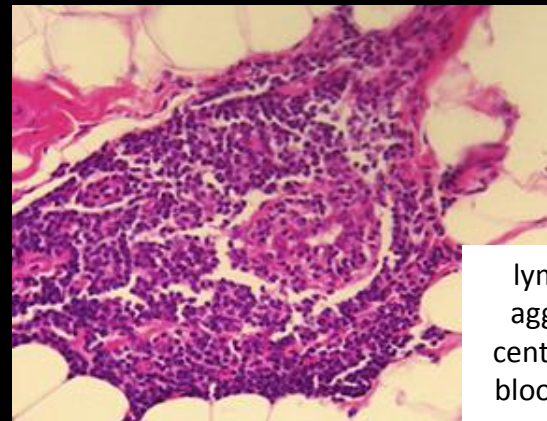

lymphoid
aggregate
centred on a
blood vessel

MoM Arthroplasty: Background

- Since 1996, more than **one million metal-on-metal** articulations have been implanted worldwide.
- Recalls on several systems, due to **high complication rates** associated with ARMD.
 - *Stryker's Rejuvenate and ABG II modular-neck hip stem system*
 - *DePuy ASR XL Acetabular System.*

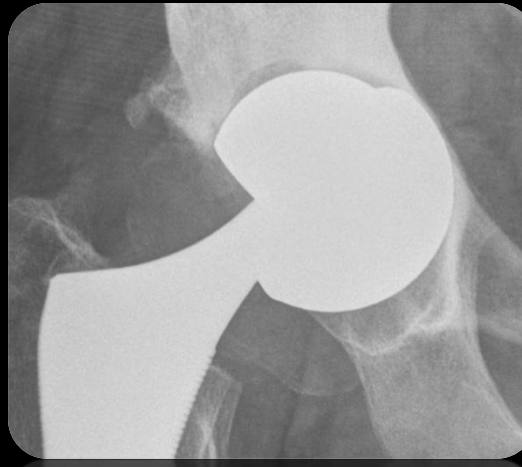

*DePuy ASR:

- >40,000 patients in the U.S ('05-'10).
- 2010: DePuy issued recall.
- 2013: >\$2.5 Billion to resolve implant lawsuits...

In the press...

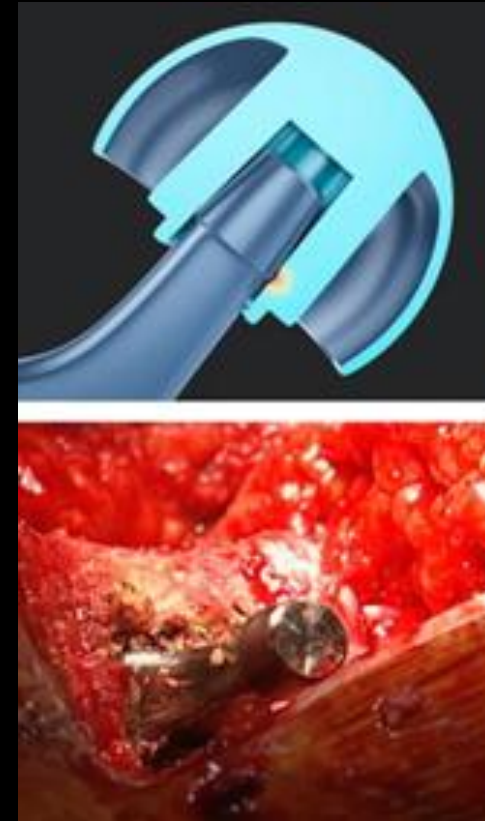

Large diameter metal-on-metal hip implant highlighting wear pattern caused by toggling on models with short tapers

MoM and Adverse Local Tissue Reactions.

- High incidence of **osteolysis, ALVAL, pseudotumors**:
 - *MRI abnormalities in up to 70%*
- Patient with significance osteolysis and soft tissue destruction may be **asymptomatic**.
 - “Silent” disease can destroy soft tissue envelope about the hip.
 - ***up to 25% re-revision rate in 5 years.***
- **How are (a)symptomatic pts with MoM implants optimally screened/evaluated?**
 - **Blood serum?**
 - for metal ions (Cr/Co)...absolute vs. trend?
 - **CR**
 - insensitive, particularly for ST lesions.
 - **Tc99m Bone Scan**
 - often negative,if osteolysis not present.
 - **U/S**
 - helpful to establish fluid collections.
 - limited and not ideal for f/u (reproducibility) .

Evaluating a patient who presents in follow-up after hip arthroplasty with a **symptomatic** metal-on-metal articulation

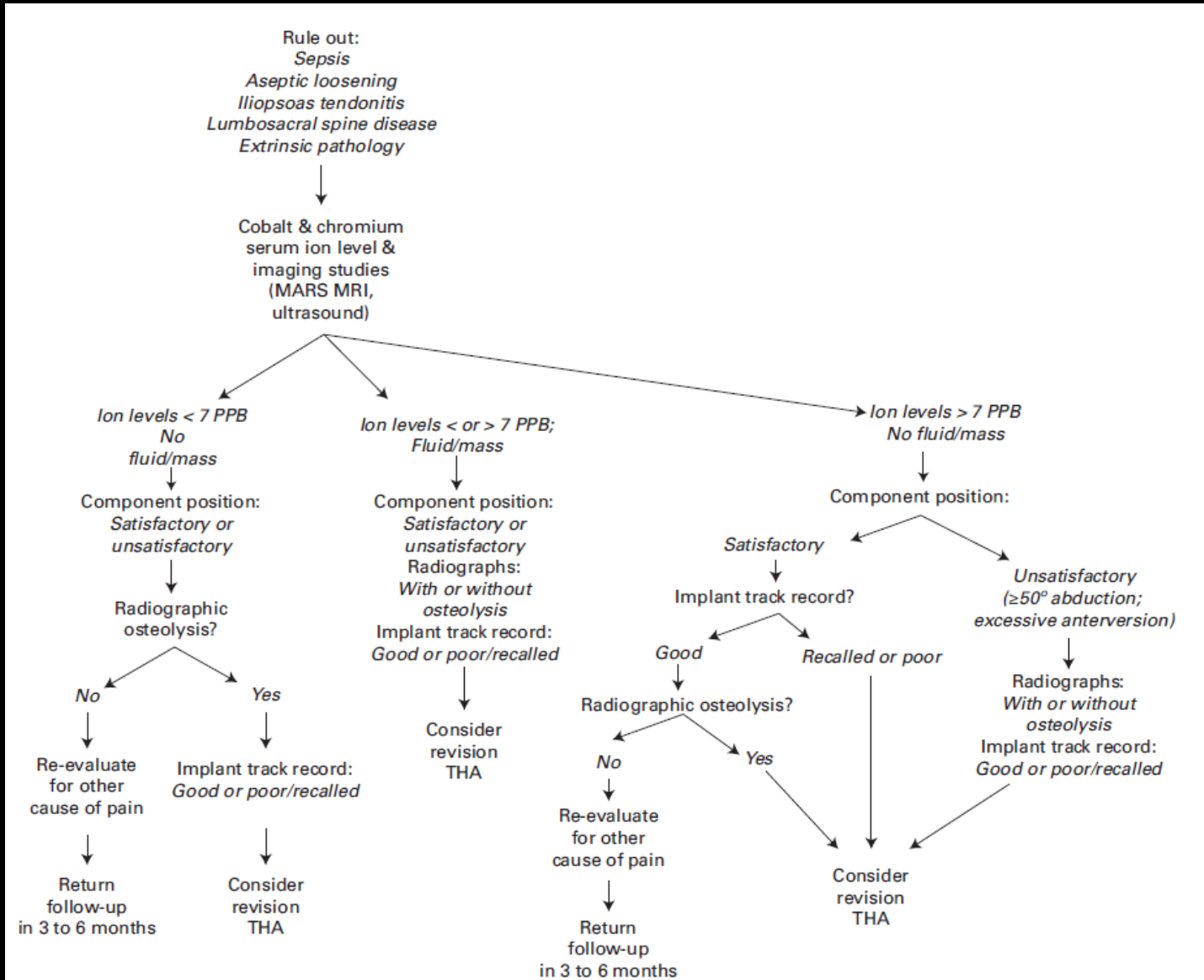

Evaluating a patient who presents in follow-up after hip arthroplasty with a **symptomatic** metal-on-metal articulation

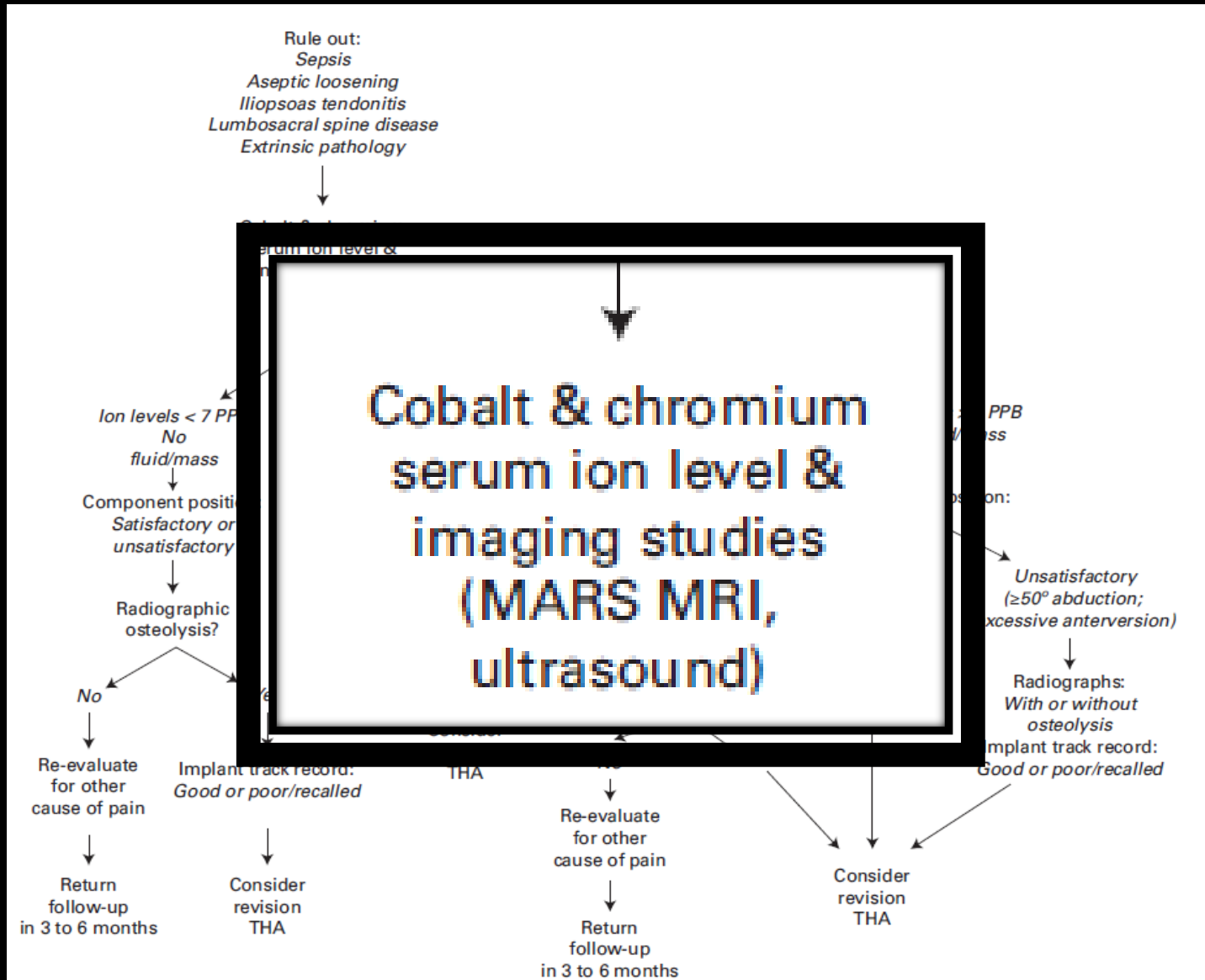

Evaluating a patient who presents in follow-up after hip arthroplasty with an **asymptomatic** metal-on-metal articulation

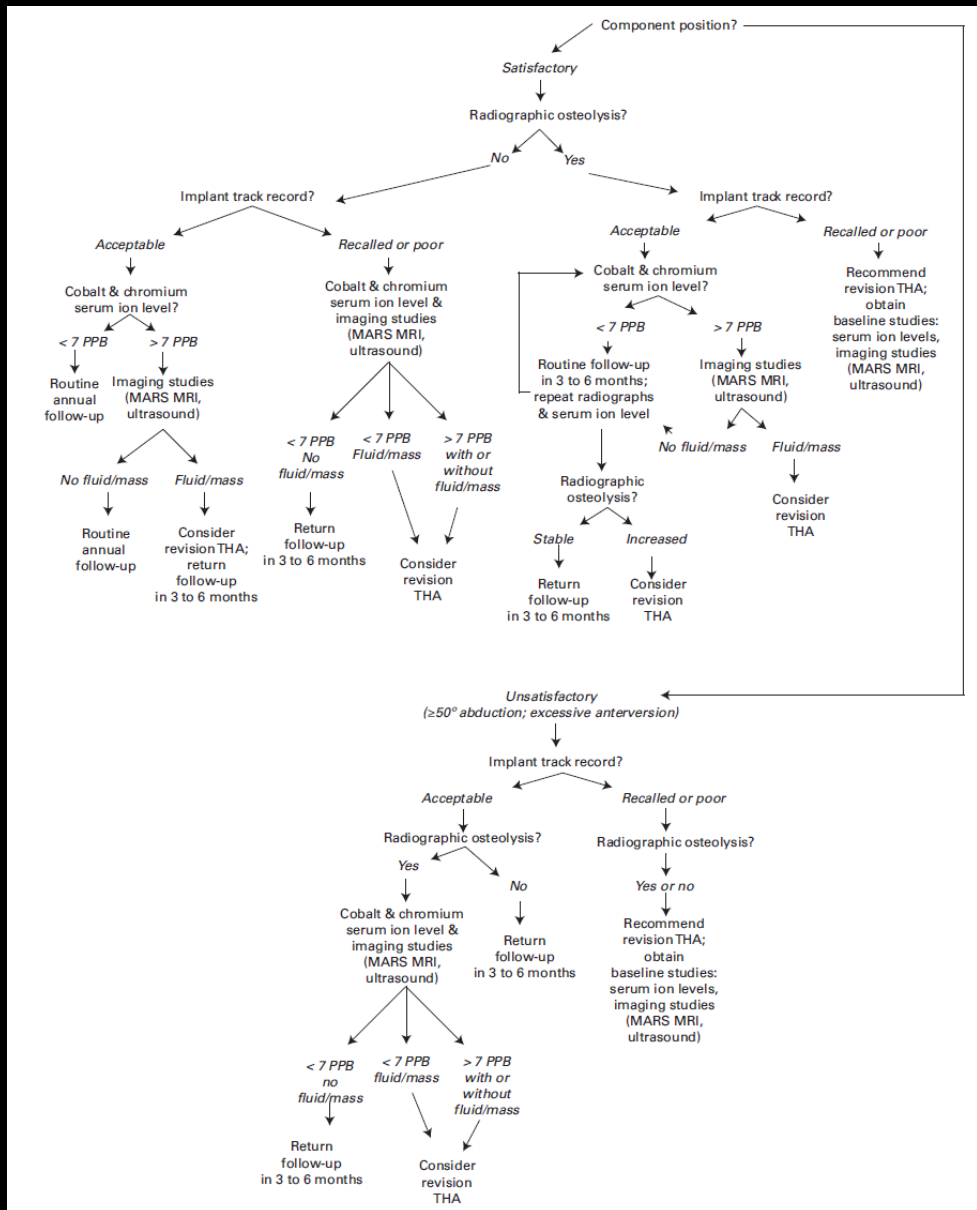

Evaluating a patient who presents in follow-up after hip arthroplasty with an **asymptomatic** metal-on-metal articulation

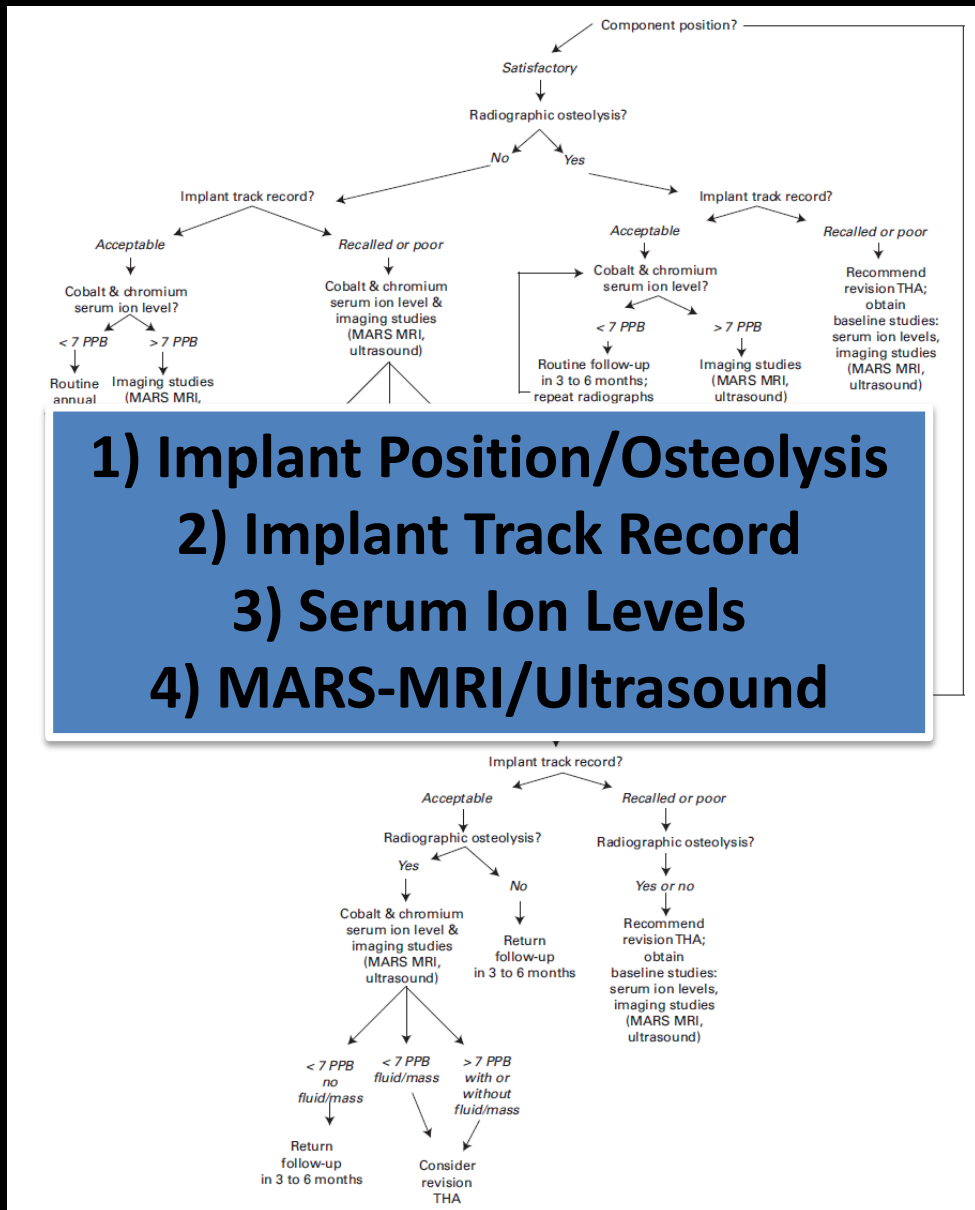

MARS-MRI:

- *Metal susceptibility artefact:*
- 1) **geometric distortion**
 - most pronounced in *spin echo imaging*.
- 2) **signal loss**
 - most pronounced *GRE*.
- **MARS = “metal artefact reduction sequences”**
 - Optimizes images by altering several imaging parameters.
 - ↓Voxel size and slice thickness
 - SE/FSE > GRE(T2*)
 - STIR > Spectral Fat saturation
 - ↓Magnet Field Strength
 - ↑Bandwidth
 - Long axis longitudinal to static magnetic field.

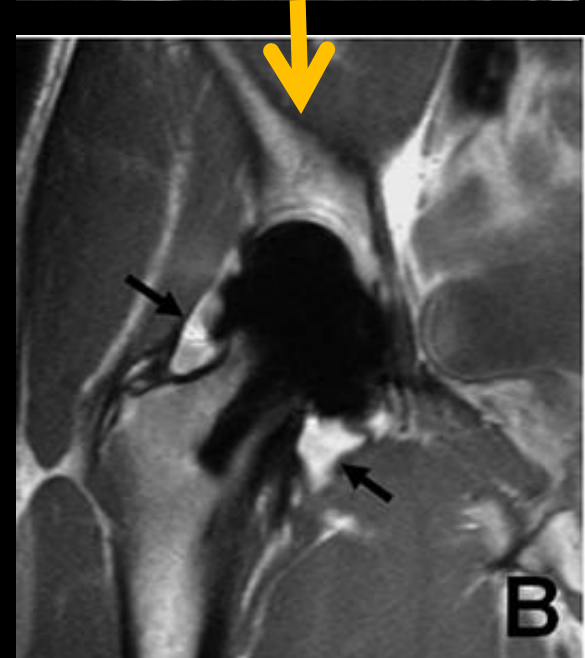
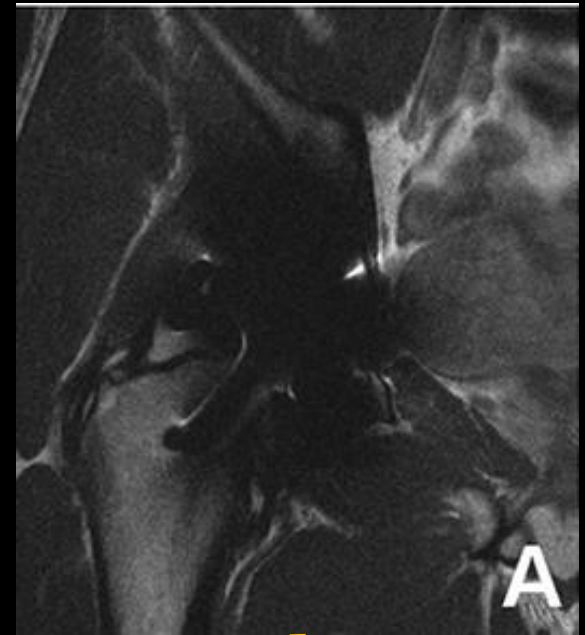

MoM Arthroplasty: Complications on MARS-MRI

- Synovitis/fluid collections
 - Decompressing into bursa
 - Thickness/volume
- Periprosthetic soft tissue masses, “pseudotumors”
- Proximal femoral BME/osteolysis
 - Fracture
- Muscle and soft tissue edema/necrosis
- Tendon avulsions (*abductor tendons*)
 - Muscle atrophy
- Neurologic compression
 - Sciatic and femoral nerves.
- Lymphadenopathy.
 - Systemic manifestation of metal debris.

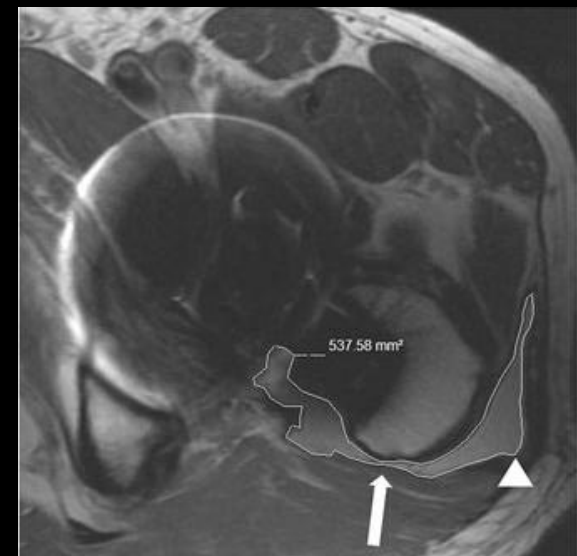

The Anderson MRI Grading System

Scoring the Severity of MoM on MARS-MRI

Table 2 Criteria for grading of MR examinations in patients with MoM hip replacements

Grade	Description	Criteria
A	Normal or acceptable	Normal post-op appearances including seromas and small haematomas
B	Infection	Fluid-filled cavity with high signal T2 wall; inflammatory changes in soft tissues; ± bone marrow oedema
C1	Mild MoM disease	Periprosthetic soft tissue mass with no hyperintense T2W fluid signal or fluid-filled peri-prosthetic cavity; either less than 5 cm maximum diameter
C2	Moderate MoM disease	Peri-prosthetic soft tissue mass/fluid-filled cavity greater than 5 cm diameter or C1 lesion with either of following: (1) muscle atrophy or edema in any muscle other than short external rotators or (2) bone marrow edema: hyperintense on STIR
C3	Severe MoM disease	Any one of the following: (1) fluid-filled cavity extending through deep fasci, (2) a tendon avulsion, (3) intermediate T1W soft tissue cortical or marrow signal, (4) fracture

“C”: Features typical of MoM disease, and subclassified based on institutional experience with decision to treat

Grade A “Normal or Acceptable”



[Axial T2W]

Thin walled fluid collection in the plane of the surgical approach consistent with a small post-operative seroma

Grade C1: “Mild MoM Disease”



Small fluid collection abutting the neck of the prosthesis with thick, ragged, low signal rim.

Progressive left hip pain, metal-on-metal replacement with posterolateral periprosthetic fluid collections with adjacent soft tissue edema.

DDx?

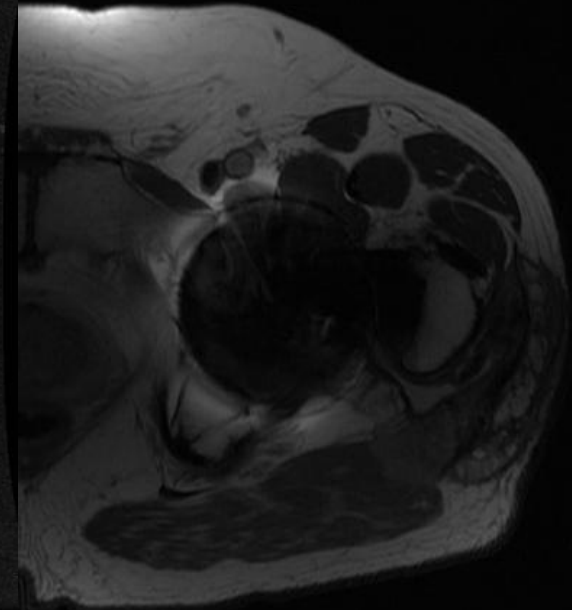
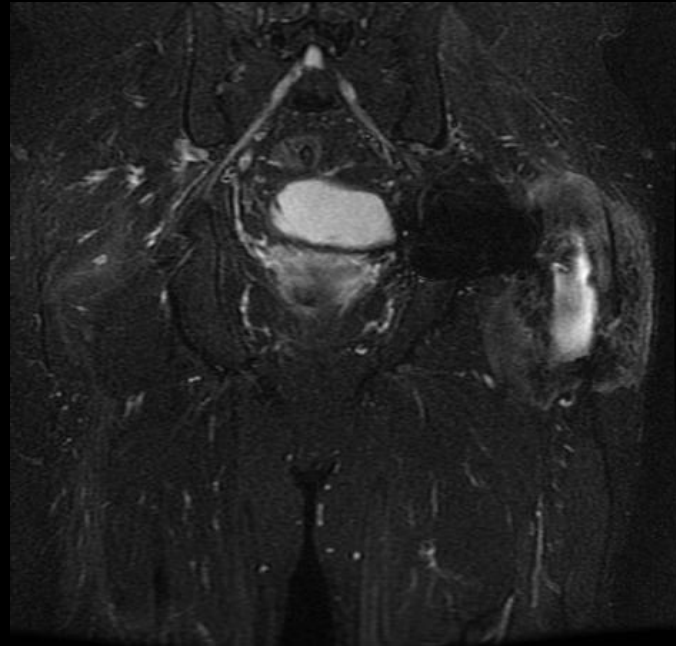

The *Anderson Grading System* has good inter-observer reliability...

problems differentiating **infection from ALVAL.

74 year old, status post fall 1 month ago. Concern for fracture.

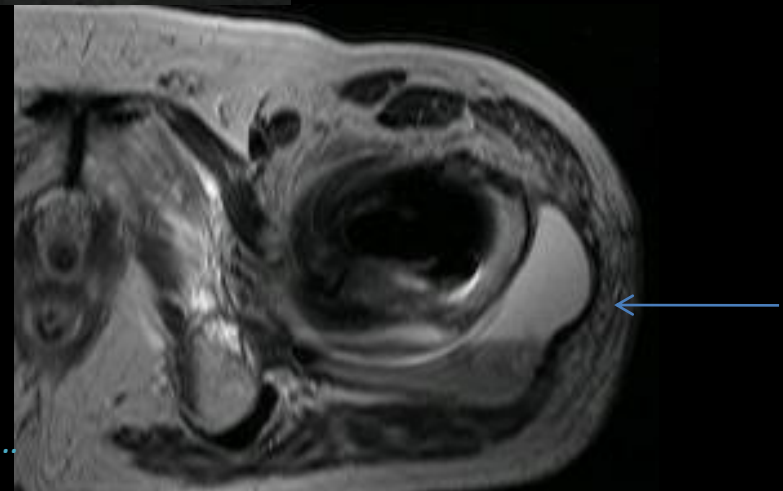
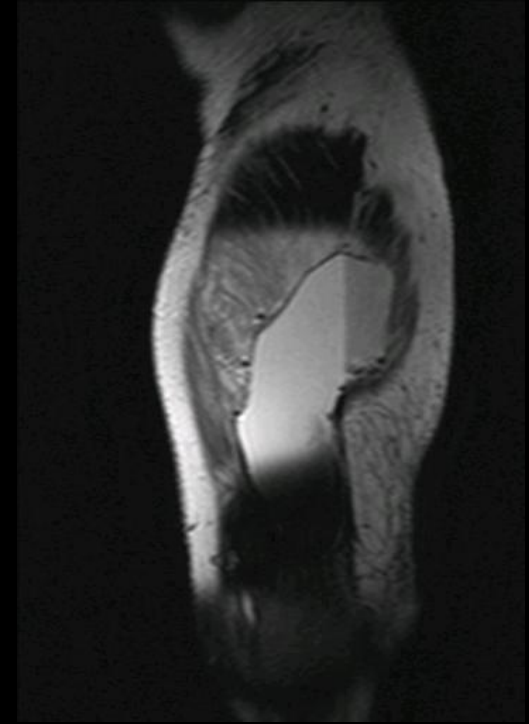
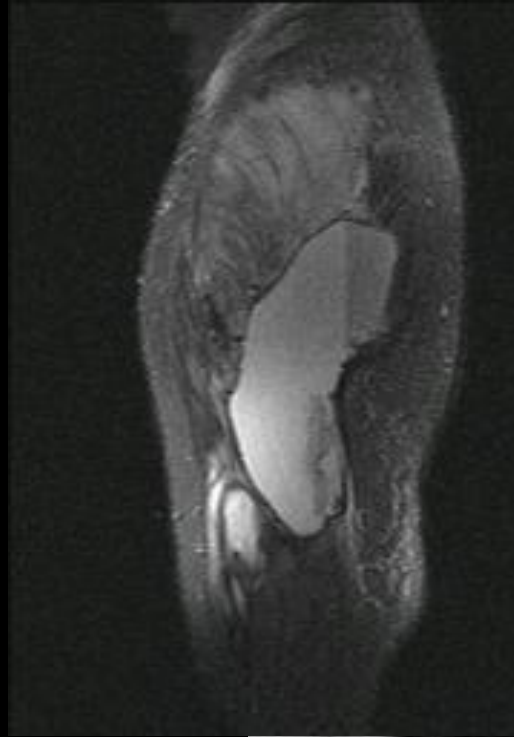
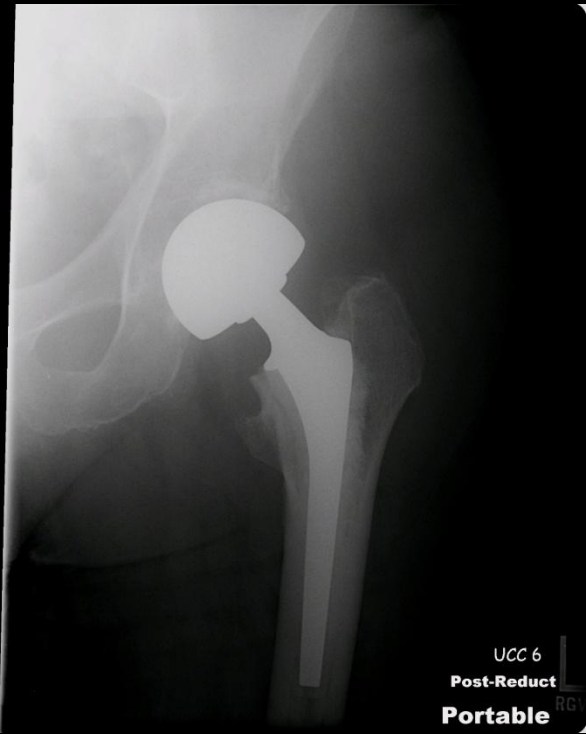

Not all fluids collections are ALVAL.
DDx: Bursitis, Seroma, Hematoma*
NB: HEVs of ALVAL may predispose to hemorrhage...

Lack of Long-term/Longitudinal Studies on the Natural History of ALVALs:

- Currently the only treatment for a ALVAL is revision surgery to a **non-MOM articulation**.
 - Outcome studies on MoM revision surgery tend to report **re-revision rate of 25% within five years**.
- *“The possibility of avoiding surgery in patients with larger **asymptomatic** pseudotumours must be considered if metal ion levels are normal and the swelling is not causing soft tissue destruction”.*

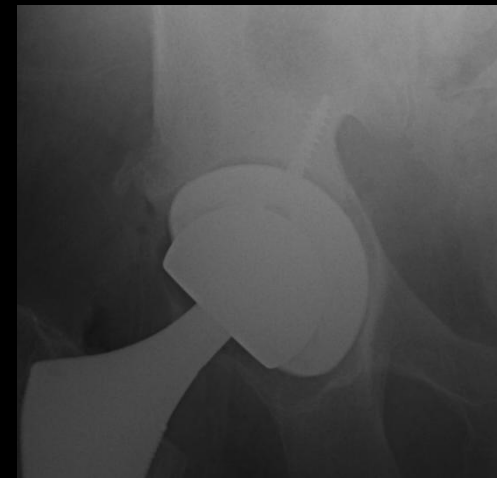

Key Points: MoM Arthroplasty and ARMD



- Evolving role of Radiology in the management of sym & asym pts with MoM arthroplasties:
 - *Asymptomatic pts may have significant tissue necrosis.*
- Quantifying & characterizing ALTR's and osteolysis.
 - *MARS-MRI*
 - *Anderson Criteria*
 - *Reproducibility*
- Longitudinally studies to clarify relevance...
 - *Reliable grading system.*
 - *Validated with surgical or histopathological outcome data.*

[4]

Aseptic Loosening

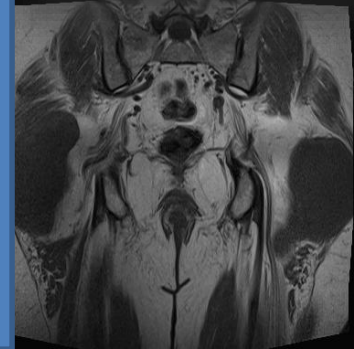
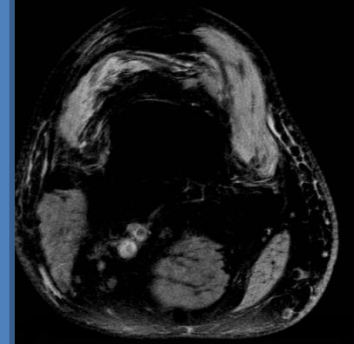



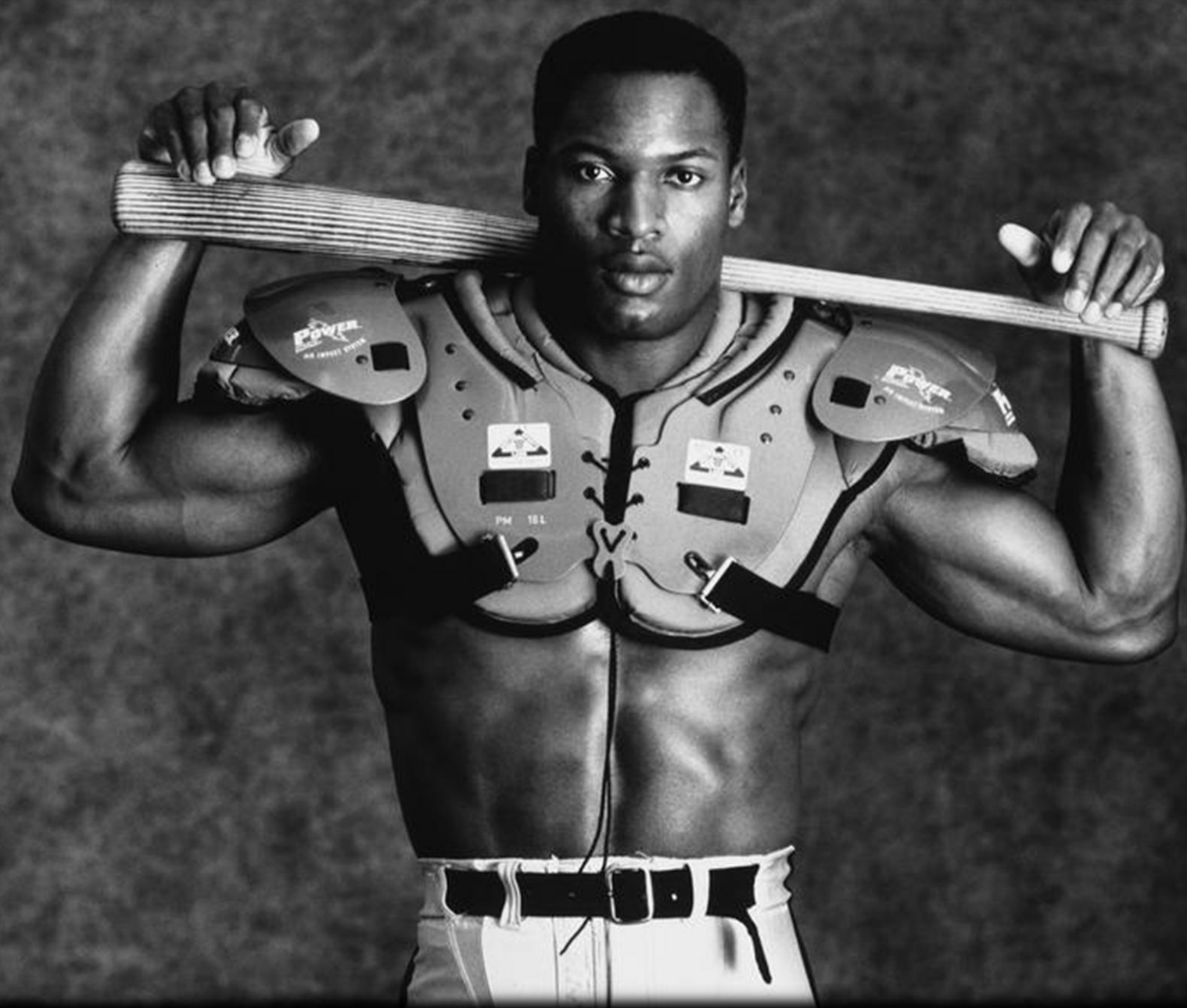

Predicting the Failure & Success/Longevity of Hip Arthroplasty:

[Patient]

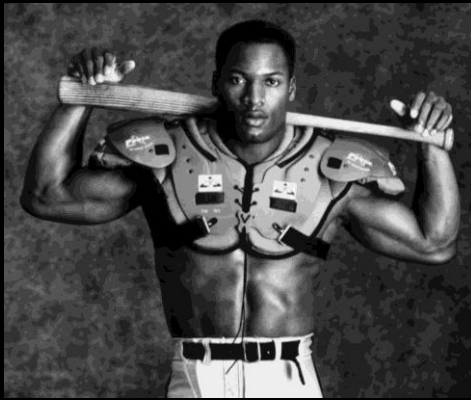

Vincent "Bo" Jackson
Returns to Major League
baseball fom '91-'94
following THA.

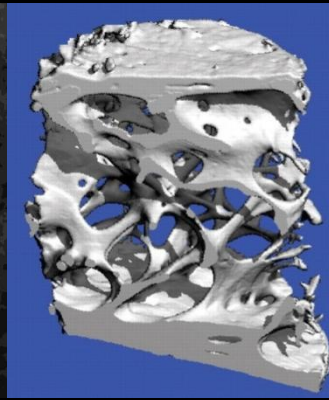

*3D microCT showing
microstructure of
transiliac bone
biopsies from a post-
menopausal woman.

[Surgeon & Technique]

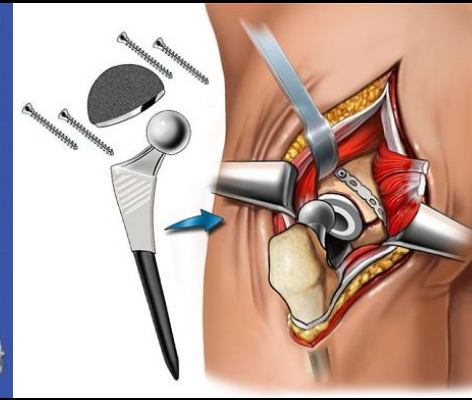

Surgical Technique and
surgical experience

[Implant Design]



***Mobelife* custom-made
implant using 3D printer

*Brandi M L Rheumatology 2009;48:iv3-iv8

**www.modelife.be

Little known fact to keep you awake:

- According to a “reliable source”, Bo did not have right hip AVN secondary to putative hip dislocation, but had chondrolysis, ultimately leading to THA.
- “Bo makes his own bow and arrows. He shot them with his feet as a part of his rehabilitation after having his hip replaced”
 - Dr. J. Stanfill, MSK fellow (his source: *ESPN 30 for 30 “You Don’t Know Bo”*)



One of the major factors limiting the longevity of hip prostheses is particle wear debris.

Wear Particles and Osteolysis:

- Particulate wear debris:
 - locally aggressive biological response → bone loss/loosening
 - End-organ retention
 - Carcinogenesis?
- '83 – “*cement disease*”
 - Lead to development of cementless prosthesis with PE and alternate bearing couples (Ceramic, Metal)
- *ALL are now known to be associated with osteolysis:
 - UHMWPE, Co-Cr, Stainless Steel...
- **Vicious cycle:**
 - Rapid progression.

R

PJV

25 MM Sphere

25





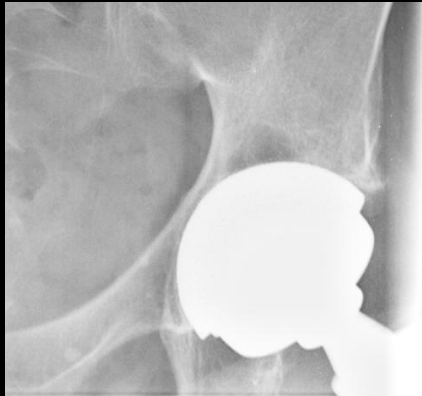

8/11/09



12/6/11



10/31/12

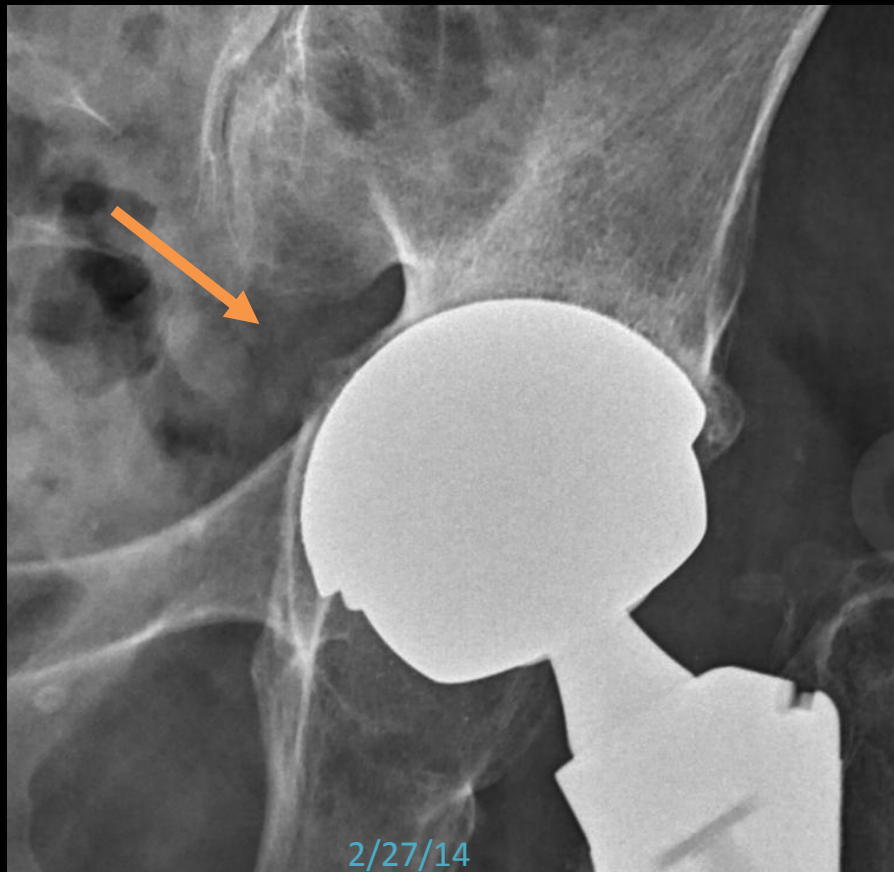

2/27/14

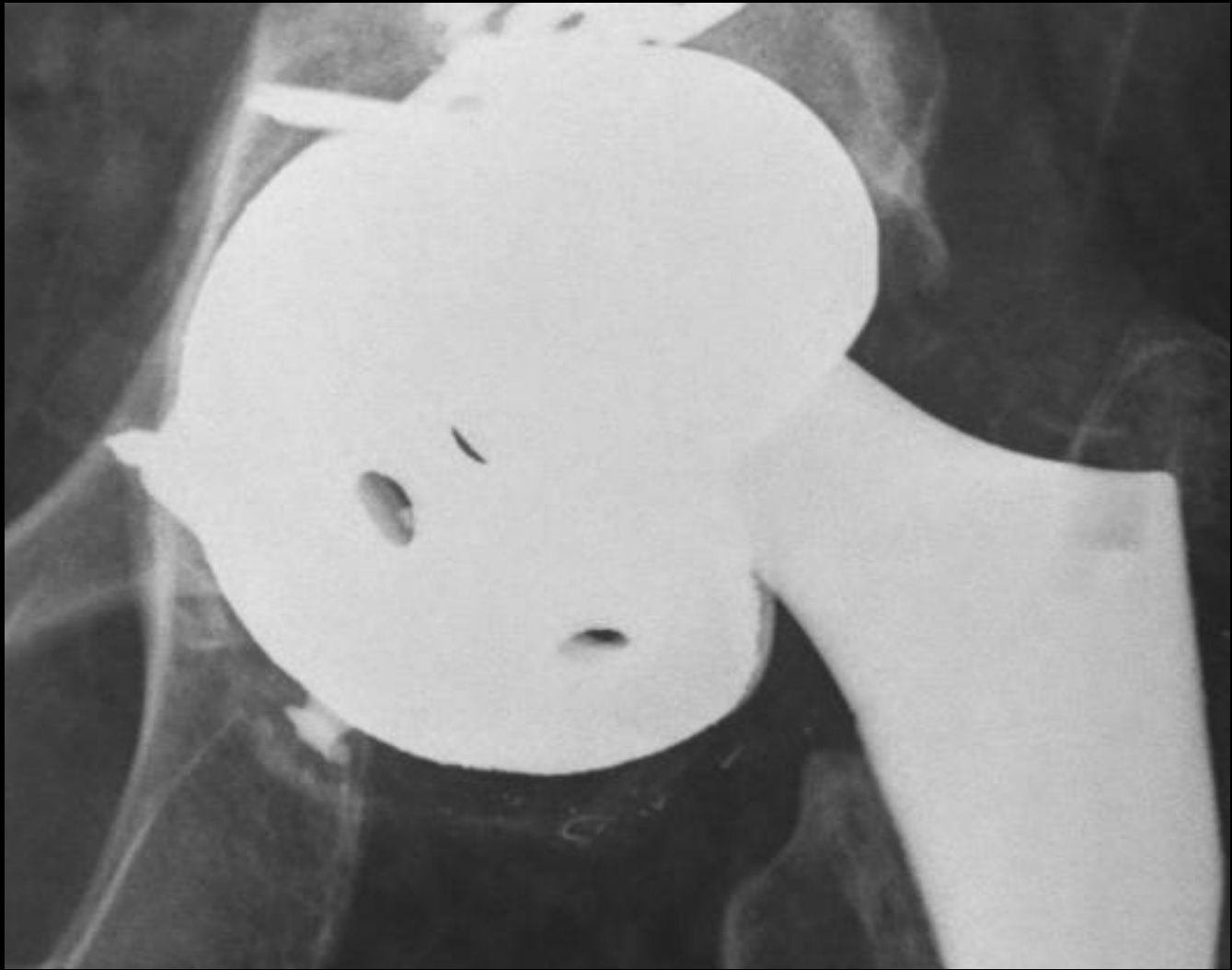

Wear and Osteolysis:

- Early identification to prevent massive osteolysis
 - Preserve bone stock for timely subsequent revision.
- AAOS Classification System: location and extent of osteolysis
 - **Acetabular:**
 - segmental = disrupts acetabular rim
 - Cavitory/contained: supporting rim intact
 - **Femoral:**
 - segmental = involves outer cortical shell
 - cavitory: intramedullary bone and inner cortical shell
- Most commonly assessed with serial radiography.
 - c/w most remote available.
 - *Often underestimates the extent of osteolysis



[Patient]



[Surgeon & Technique]

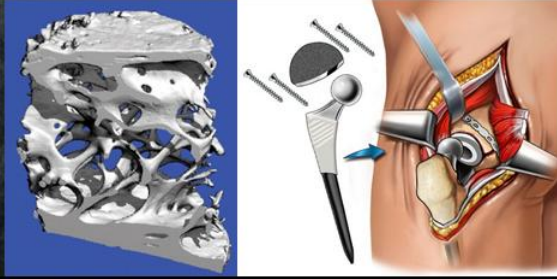

[Implant Design]



INDEPENDENT OF PATIENT-RELATED FACTORS AND SURGICAL TECHNIQUE, SOME IMPLANT DESIGNS HAVE A HIGHER PROPENSITY FOR FAILURE...

How do we detect this before mass distribution?

“Phased Introduction” of New Implants.

- Joint registries & imaging techniques to detect loosening/wear in the *pre-clinical phase*
 - *Before major complications arise*
 - *Before mass distribution...*

Techniques for Detection of Hip Prosthesis Loosening:

- Conventional radiography
- Arthrography (*effective joint space*)
- CT/MRI
- Nuclear Medicine Tc-99 Bone Scan
- ***Ultrasound: “Vibrometry”***
- ***Radiostereometric Analysis***

Ultrasound: “Vibrometry”

- Acoustic-mechanical method to detect implant loosening
- Low frequency (<1000 Hz) sinusoidal vibration applied to the femoral condyles and the resulting vibration is measured at the greater trochanter.
 - Securely fixed prosthesis: output vibration matches input.
 - Loose prosthesis: output vibration distorted/marked harmonics.
- **Limited in the presence of significant prominent soft tissue.*

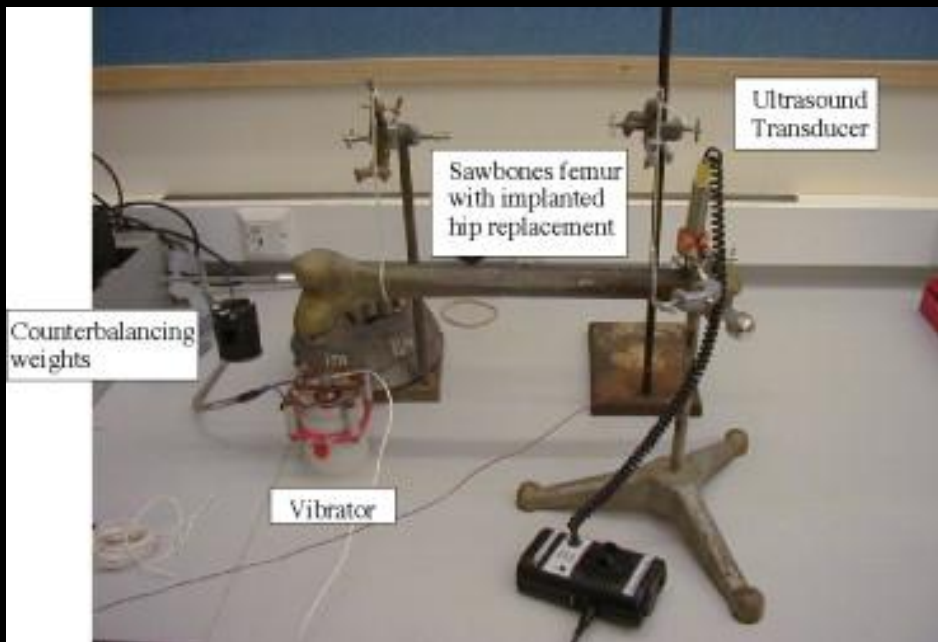

Rowlands A et al. *Med Eng Phy.* 2013; 30(3).

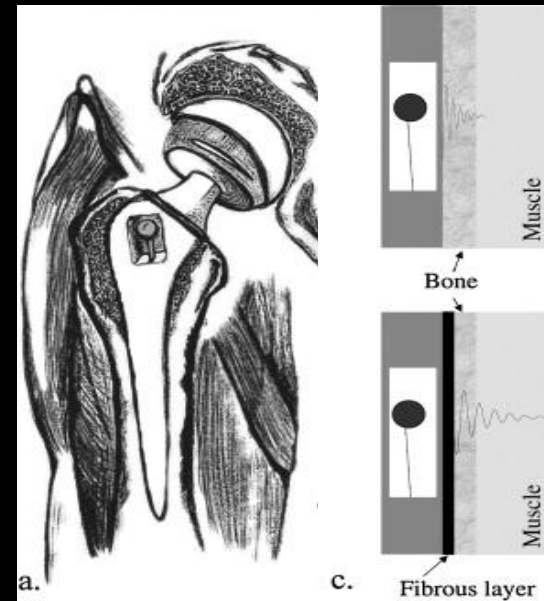

prosthetic
implant with
integrated
oscillator

Ruther, C et al. *Med Eng Phy.* 2013; 35(3).

Radiostereometric Analysis

The Technique:

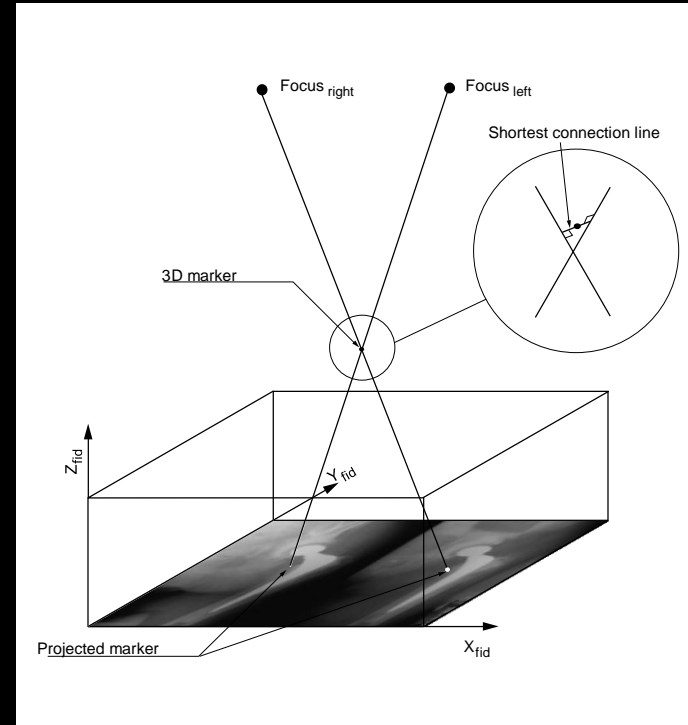
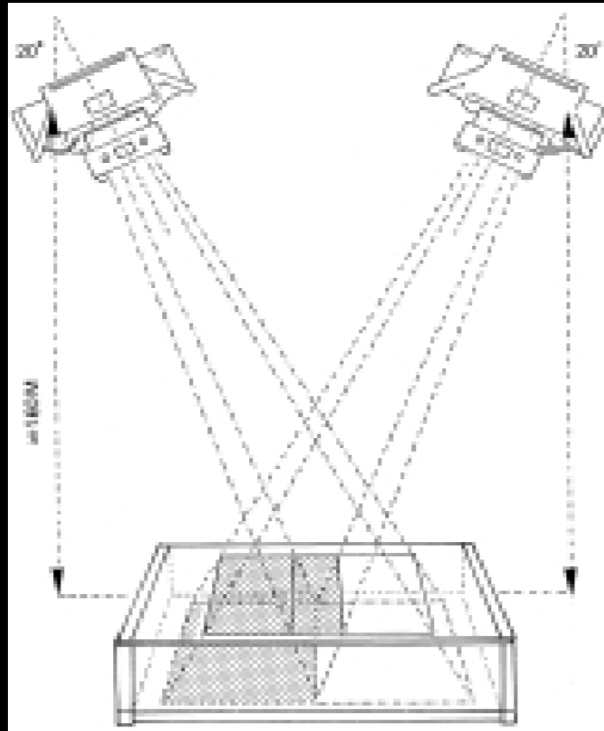
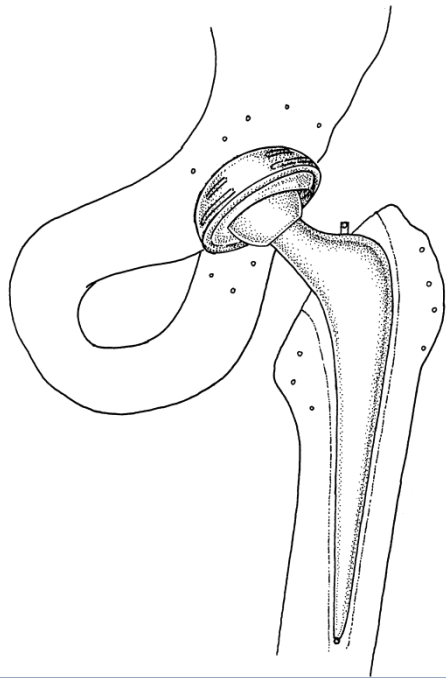

Tantalum Beads inserted into bone at time of THA to form a "rigid body"

Two synchronized roentgen tubes are positioned above a calibration box.

3D position of a marker is located on the shortest connection line between its two projection lines.

Radiostereometric Analysis: The Equipment:

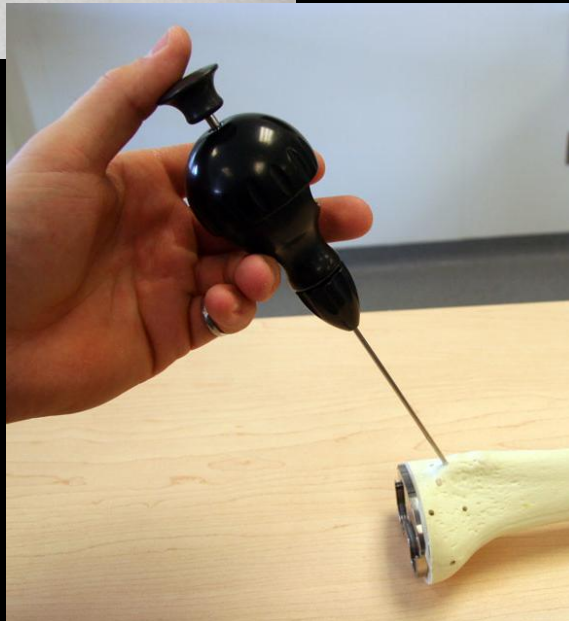
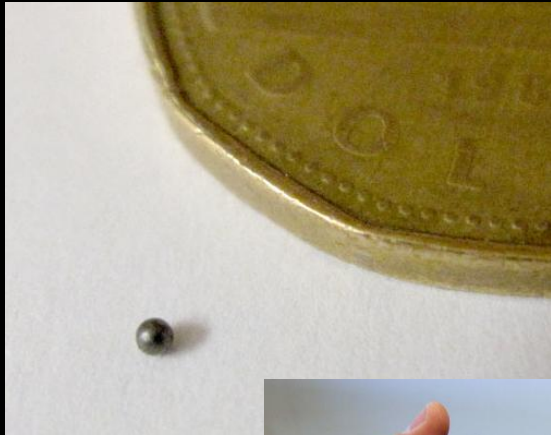

Images are analyzed to determine the relative motion between the reference beads in the bone and predetermined reference points on the implanted hardware.

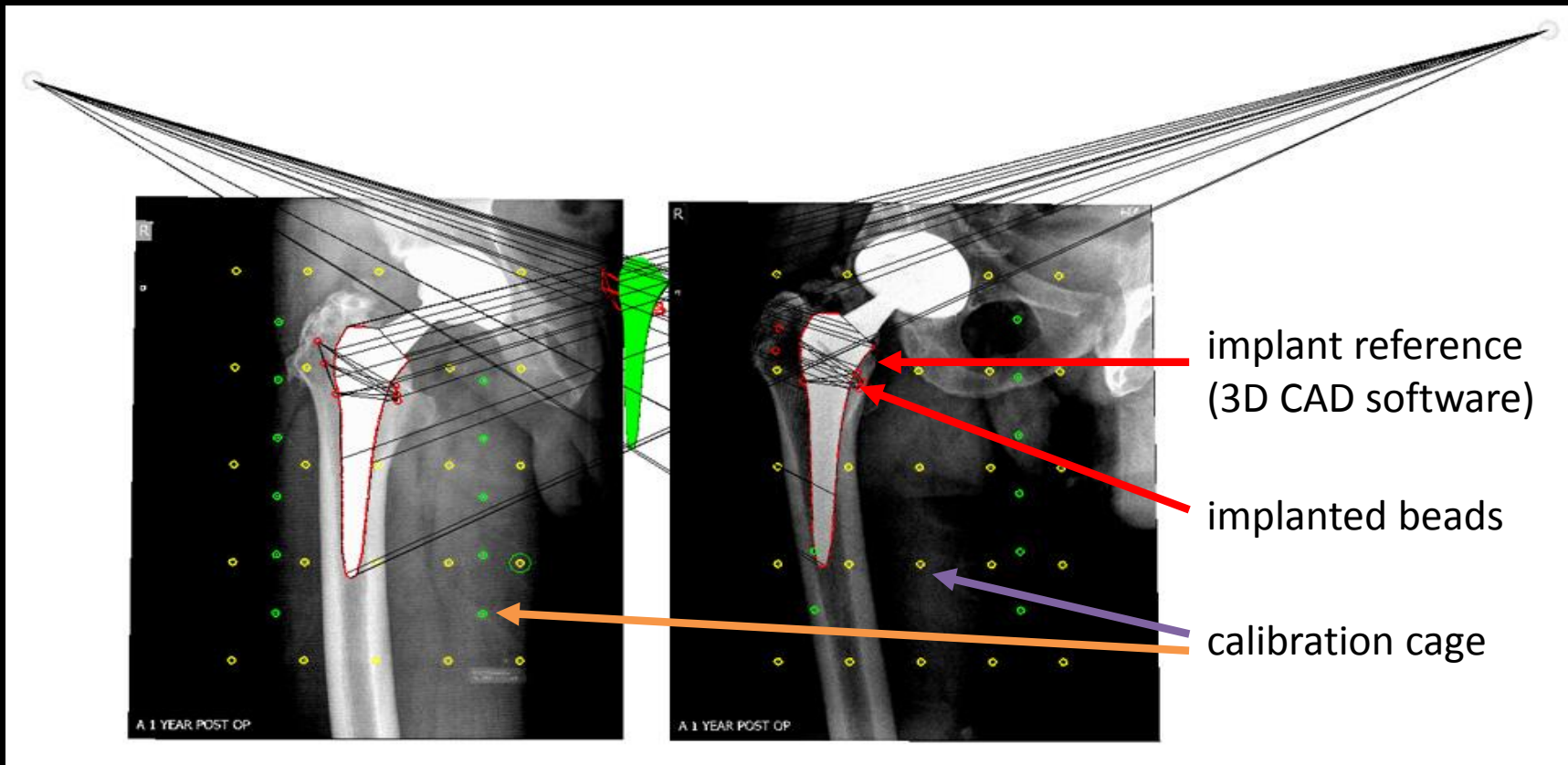

Translation
Subsidence
Rotation

ACCURACY OF $\sim .03$ mm

Early Micromotion is Predictive of Loosening:

- **Pijls, BG et al (Acta Orthop. 2012):**
 - Clinically relevant association b/w early migration of acetabular cups and late revision due to loosening.
 - **0.2-1.0 mm proximal migration:**
= Revision rates > 5% at 10 years.
 - Proposed “*migration thresholds*”
 - early detection of high-risk cups while exposing a small number of patients.
- **Hauptfleisch, J et al (J Bone Joint Surg Br, 2006):**
 - 118 pts at a mean of 9 years after hip replacement with Charnely-Elite femoral component.
 - All pts with significantly higher posterior head migration in the early postoperative RSA (first two years) went on to have premature loosening.
 - Not only identify THAT this design would fail, but WHY (internal rotation of femoral stem)

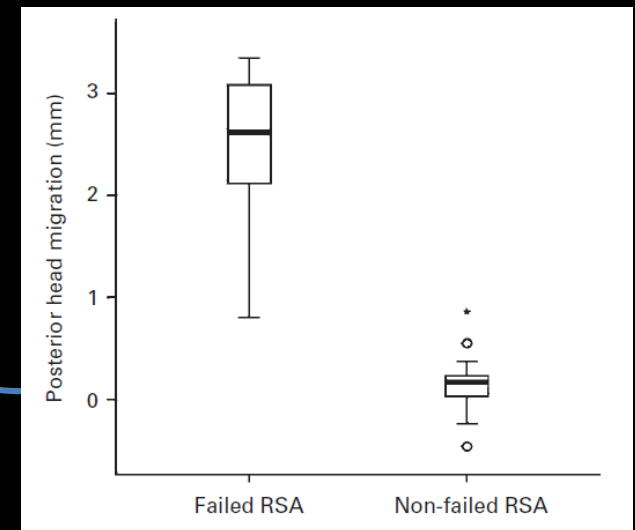
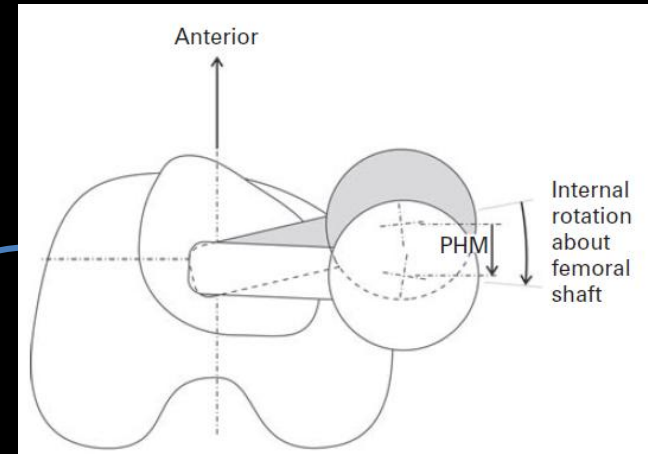

100% failure
at 9 years

7% failure
at 9 years

Early Micromotion is Predictive of Loosening:

- **Pijls, BG et al** (*Acta Orthop. 2012*):
 - Clinically relevant association b/w early migration of acetabular cups and late revision due to loosening.

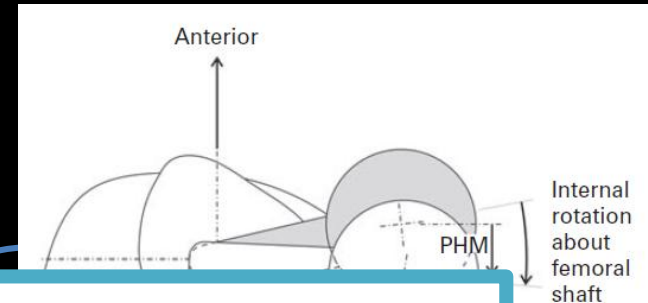

GOAL:

Better patient care/improve patient safety
Reduce the costs associated with revision arthroplasty.

- **Hauptfleisch, J et al** (*J Bone Joint Surg Br, 2006*):
 - 118 patients at a mean of 9 years after hip replacement with Charnely-Elite femora I component.
 - All pts with significantly higher posterior head migration in the early postoperative RSA (first two years) went on to have premature loosening.
 - Not only identify THAT this design would fail, but WHY (internal rotation of femoral stem)

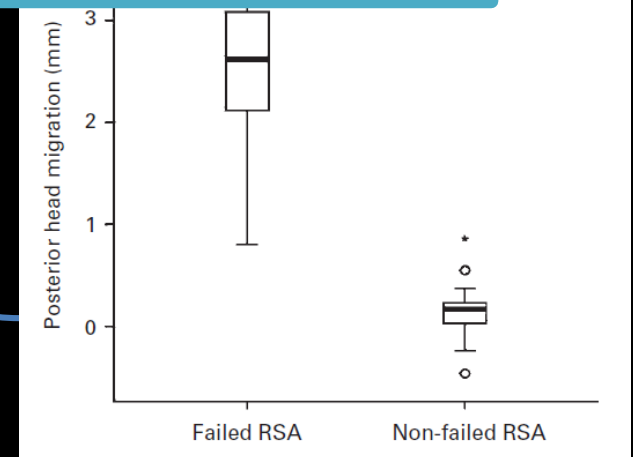

100% failure
at 9 years

7% failure
at 9 years

Key Points: Aseptic Loosening



- **Lucency vs. Loosening**
 - *Normal fibrous tissue surrounding stable implant.*
 - *Progressive: Aseptic vs. Septic*
 - *c/w remote CR's*
 - *lung nodule approach*
- **Multiple modalities for detection of osteolysis**
 - *MARS-MRI promising technique, more Sn than CR.*
- **Phased introduction of new prothesis.**
 - *Combining new techniques which predict future failure rates*
 - *Radiology involvement in the R&D process.*

Summary:

- Heterotopic Ossification
 - Brooker Classification
 - CT/MRI of Stage “0”
- Neuropathies:
 - Common peroneal nerve
 - Early recognition to prevent irreversible nerve damage
 - Significant of denervation muscle edema?
- Adverse Reaction to Metal Debris
 - ARMD
 - MARS
 - Anderson Classification
- Aseptic Loosening:
 - Micromotion predictive of early implant failure
 - Phased introduction of new implants
 - RSA

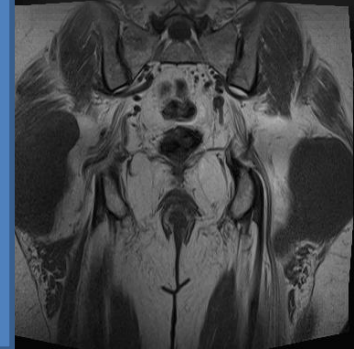
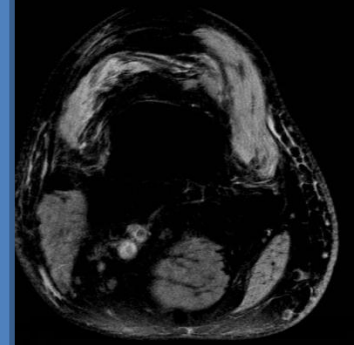

Thank you to:

- Several colleagues for providing me with case examples:
 - *Dr. K. Chen*
 - *Dr. B. Huang*
 - *Dr. T. Hughes*
 - *Dr. M. Pathria*
 - *Dr. T. Wagner*
 - *Dr. M. Zakhary*

REFERENCES

General:

- Mulcahy H & Chew FS. **Current Concepts of Hip Arthroplasty for Radiologists: Part 1, Features and Radiographic Assessment.** *AJR* 2012; 199:559–569.
- Mulcahy H & Chew FS. **Current Concepts of Hip Arthroplasty for Radiologists: Part 2, Revisions and Complications.** *AJR* 2012; 199:570–580.

Heterotopic Ossification

- Choi YH, Kim KE, Lim SH, Lim JY. Early presentation of heterotopic ossification mimicking pyomyositis - two case reports -. *Ann Rehabil Med.* 2012 Oct;36(5):713-8.
- Kantor SR, Cummins J, Tunzeer M. Complications after Total Hip Arthroplasty. *Sem in Arthro.* 2005; 16:105-113.
- Ledermann HP, Schweitzer ME, Morrison WB. Pelvic heterotopic ossification: MR imaging characteristics. *Radiology.* 2002 Jan;222(1):189-95.
- Shehab D, Elgazzar AH, Collier BD. Heterotopic ossification. *J Nucl Med.* 2002 Mar;43(3):346-53.
- Zagarella A, Impellizzeri E, Maiolino R, Attolini R, Castoldi MC. Pelvic heterotopic ossification: when CT comes to the aid of MR imaging. *Insights Imaging.* Oct 2013;4(5):595-603.

Neuropathies:

- Hayter CL, Koff MF, Potter HG. Magnetic resonance imaging of the postoperative hip. *J Magn Reson Imaging.* 2012 May;35(5):1013-25.
- Butt AJ, McCarthy T, Kelly IP, Glynn T, McCoy G. Sciatic nerve palsy secondary to postoperative haematoma in primary total hip replacement. *J Bone Joint Surg Br.* 2005 Nov;87(11):1465-7.
- Fox AJ, Bedi A, Wanivenhaus F, Sculco TP, Fox JS. Femoral neuropathy following total hip arthroplasty: review and management guidelines. *Acta Orthop Belg.* 2012 Apr;78(2):145-51.
- Fowble, VA et al. Nerve Palsy Associated with Total Hip Arthroplasty.. *Sem in Arthro.* 2005; 16:114-118.
- Gogus A, Ozturk C, Sirvanci M, Aydogan M, Hamzaoglu A. Femoral nerve palsy due to iliacus hematoma occurred after primary total hip arthroplasty. *Arch Orthop Trauma Surg.* 2008 Jul;128(7):657-60

Small Particle Disease/ARMD:

- Lombardi AV Jr, Barrack RL, Berend KR, Cuckler JM, Jacobs JJ, Mont MA, Schmalzried TP. The Hip Society: algorithmic approach to diagnosis and management of metal-on-metal arthroplasty. *J Bone Joint Surg Br.* 2012 Nov;94(11 Suppl A):14-8.
- Natu S, Sidaginamale RP, Gandhi J, Langton DJ, Nargol AV. Adverse reactions to metal debris: histopathological features of periprosthetic soft tissue reactions seen in association with failed metal on metal hip arthroplasties. *J Clin Pathol.* 2012 May;65(5):409-18.
- Anderson H, Toms AP, Cahir JG, Goodwin RW, Wimhurst J, Nolan JF. Grading the severity of soft tissue changes associated with metal-on-metal hip replacements: reliability of an MR grading system. *Skeletal Radiol.* 2011 Mar;40(3):303-7.
- van der Weegen W, Brakel K, Horn RJ, Hoekstra HJ, Sijbesma T, Pilot P, Nelissen RG. Asymptomatic pseudotumours after metal-on-metal hip resurfacing show little change within one year. *Bone Joint J.* 2013 Dec;95-B(12):1626-31.
- Muller, M.E., The Benefits of Metal-on-Metal Total Hip Replacements, *Clin Ortho and Rel Research*, 311: 54-59, 1995.

Aseptic Loosening:

- Bozic, KJ & Reis MD. Wear and Osteolysis in Total Hip Arthroplasty. *Sem in Arthro.* 2005; 16:142-152.
- Nelissen, R.G., et al., RSA and registries: the quest for phased introduction of new implants. *J Bone Joint Surg Am*, 2011. 93 Suppl 3: p. 62-5.
- Pijls, B.G., et al., Early proximal migration of cups is associated with late revision in THA: a systematic review and meta-analysis of 26 RSA studies and 49 survival studies. *Acta Orthop*, 2012. 83(6): p. 583-91.
- Rieger JS, et al. A vibrational technique for diagnosing loosened total hip endoprostheses: An experimental sawbone study *Medical Engineering & Physics*, Volume 35, Issue 3, Pages 329-337
- Rowlands A et al. Bone vibration measurement using ultrasound: Application to detection of hip prosthesis loosening *Medical Engineering & Physics*, Volume 30, Issue 3, Pages 278-284
- Ruther, C et al. Investigation of an acoustic-mechanical method to detect implant loosening *Medical Engineering & Physics*, Volume 35, Issue 11, Pages 1669-1675.

Questions/Comments?

- christina.paquette@dal.ca